

W3

Smart Face Recognition Terminal

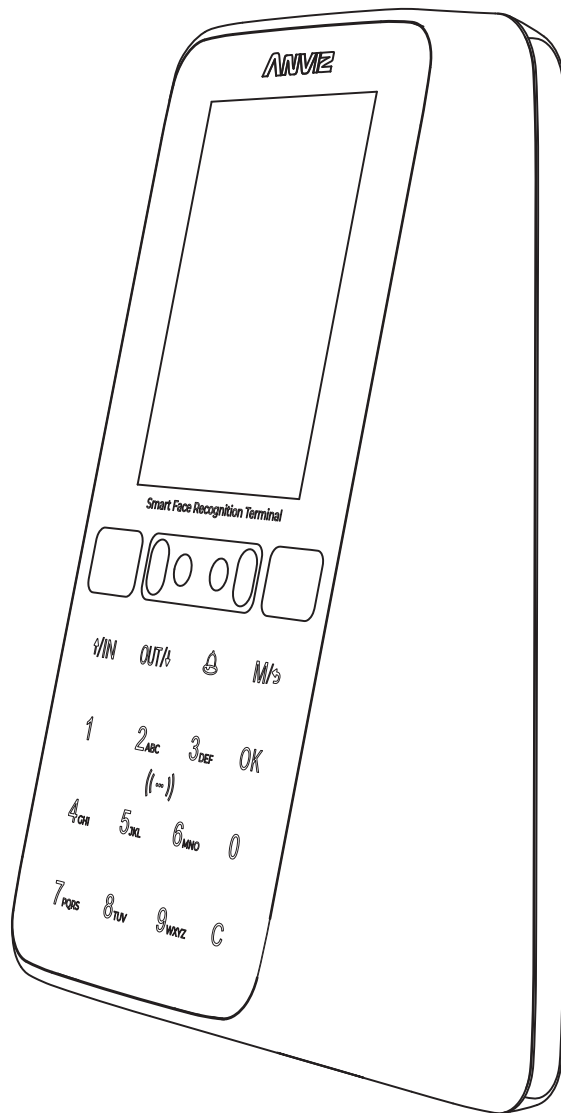

CONTENTS

Product Introduction

Appearance Description & Components
Safety Instructions
Installation
Wiring Connection

Device Operation

General Settings
Enroll Face

User

Add User
Modify User
Delete User
Search User
Admin Level

Data Menu

Record

Network Settings

Ethernet
WIFI
Internet
Comm. Mode
Cloud

Settings Menu

Device Information
Time
Display Settings
Basic Information
Test

Advanced

T&A (Time Attendance)
Application
Verify Mode
FN Settings
Auto FN

FAQ

Warranty and Service

Introduction

W3 is a facial attendance and access control device in the W series, targeted towards the mid-to-low-end market applications.

- Its main customer base includes office environments and various scenarios.
- The device is primarily used for attendance purposes, accounting for 70% of its application, while access control constitutes the remaining 30%.
- The W3 features a 2.8-inch screen and supports up to 200 facial users.
- It offers multiple verification methods, including password, card, and facial recognition.
- Furthermore, the device has been optimized for easy installation and use, with a focus on improving access control functionality. Its exquisite design and appearance seamlessly blend into modern office environments, making it simpler and faster to manage your workplace.

Appearance Description

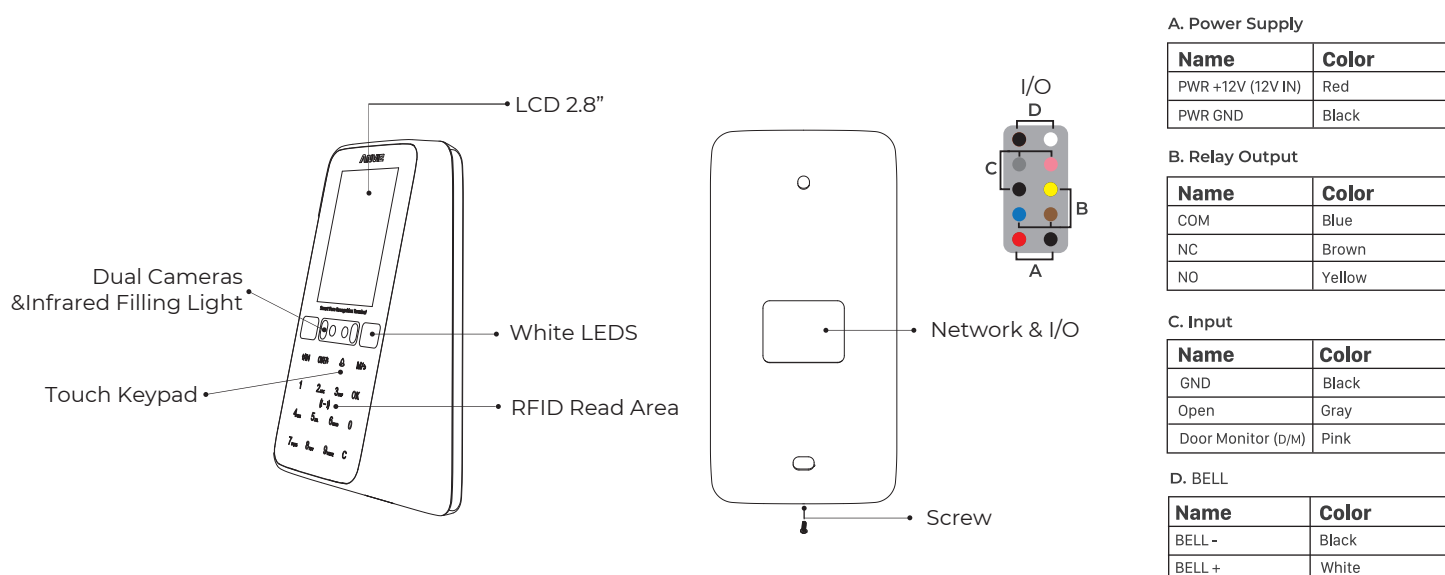

Safety Instructions

Observe the following instructions to use the product safely and prevent any risk of injury or property damage.

- Do not use oily water or sharp objects to stain or damage the display screen.
- Fragile parts are used in the equipment, please avoid operations such as falling, crashing, bending or heavily pressing.
- The optimal working environment of W3 is indoor. The device function fully under temperature: $-10^{\circ}\text{C}\sim 50^{\circ}\text{C}$ ($14\sim 122^{\circ}\text{F}$), humidity: 20- 90%. The best performance is between: $15^{\circ}\text{C}\sim 32^{\circ}\text{C}$ ($59\sim 89.6$). The device will be less effective excess these ranges.
- Please gently wipe the screen and panel with soft materials. Avoid scrubbing with water or detergent.
- The recommended power of W3 terminal is DC 12V 2A. The device will function effectively in case the power supply cable extended too long.
- If there is no ambient light, it will affect the face recognition distance of W3. Please use it under normal indoor lighting conditions.

Installation

The Sunlight and Hard Light may lead to big difference between site image and registered image; backlight, side-light and strong light will influence the recognition experience.
 (Notice: from the view of human eyes, the color changes on face skin may result in wrong recognition of of identity; uncler exposure area, no matter large or small, may influence the identity judgement)



Side Light











Strong Light



Back Light

Device shall be installed in places avoiding backlight, side-light, strong light and direct sunlight.

-  The recommended place for Installation (Please keep 3m away from the window, or does not influenced by sunlight, can be considered for installation)
-  Backlight, side-light or direct strong light, not suitable for installation.
-  Other areas, install in suitable places according to actual light impact.
-  Hard Light
-  Door
-  Wall
-  Curtain
-  Glass Window or Glass Wall

Sunlight Shines Indoor

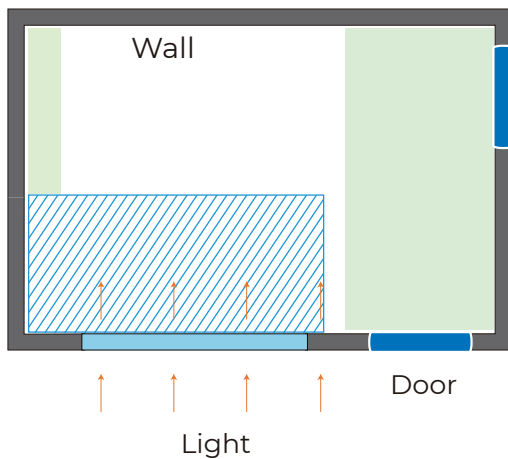

Glass Window

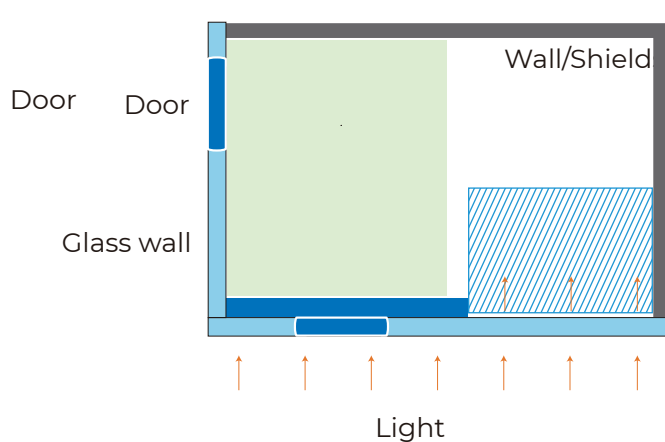

Sunlight Shines Through the Door, with Glass Window at One Side

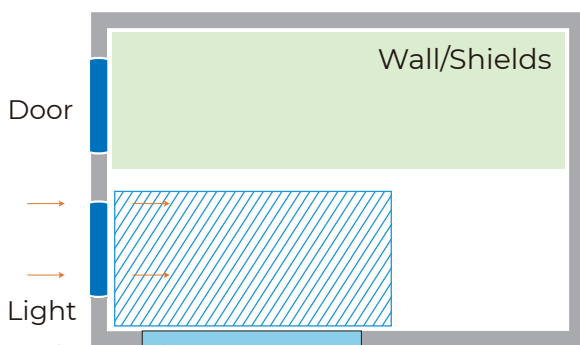

Sunlight Shines Through the Door

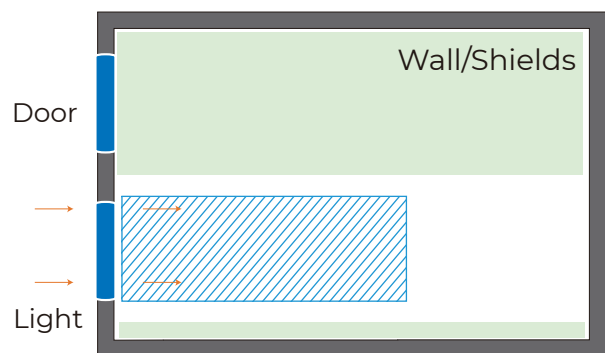

Installation Position

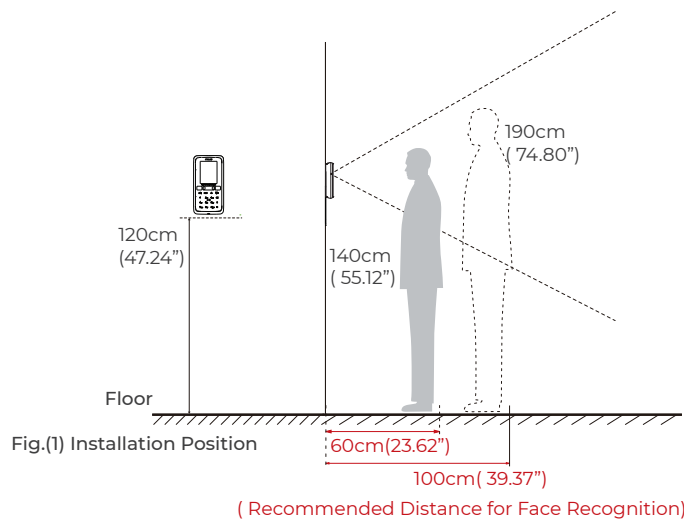

Suggested installation height (the distance between the lens and the ground is 1.2m(47.24"), as the recognizable body height range, 0.6m(23.62") distance away from the device, is 1.4-1.6m (55.12" -63.00"); the recognizable body height range, 1.0m (39.37") distance away from the device, is 1.4-1.9m(55.12"-74.80"). (There are some deviations) .

Installation Steps

- 1 Keep the mounting bracket parallel with the ground and 1.2m distance to the ground. Drill 2 screw holes on the wall according to the mounting bracket ,

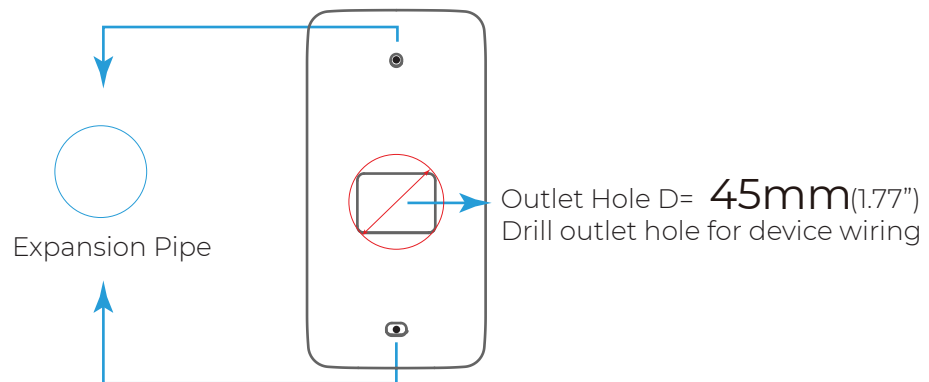

- 2 Please punch out the tail lines from the outlet hole before installing the mounting bracket and use the screws to fix the mounting bracket on the wall. Use the screwdriver to tighten the screw follow the direction indicated, to complete the installation.

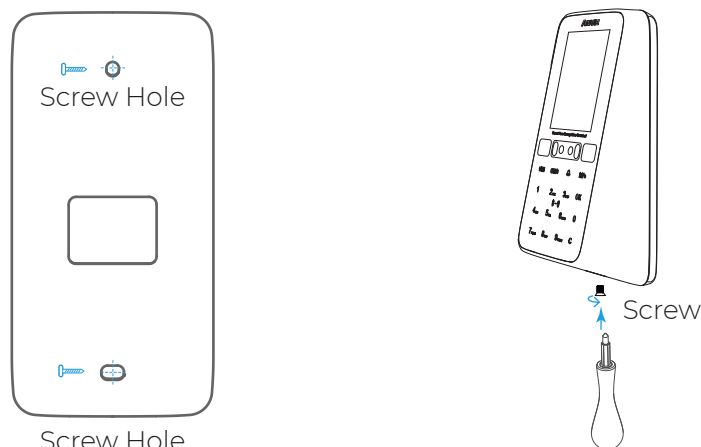

Wiring Connection

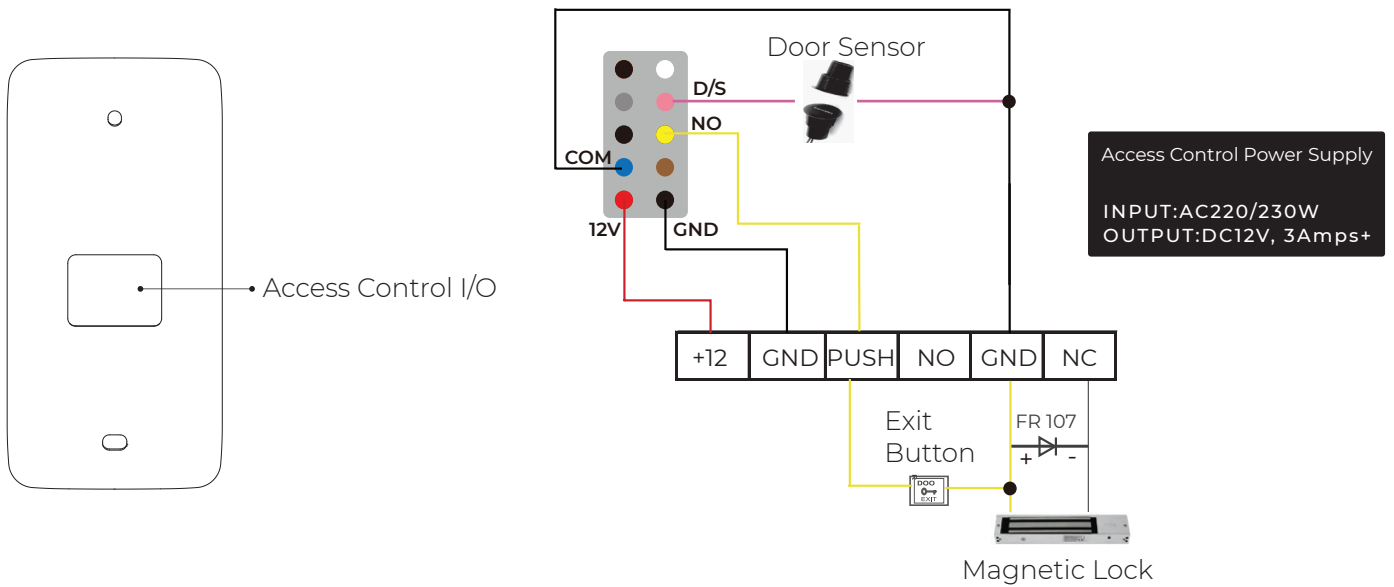

Device Operation

- 1 After completing the Device Setup Guide please Click "M", then enter the admin ID and password to access the main menu. (The default administrator account: ID is 0 and the password is 12345.)
- 2 Select the options by tapping the number on the keypad. (Number 1,2,4,5,7,8. As per the position) or Tap "↑/IN" or "↓/OUT" on the keypad to select the options, and tap "OK" to enter the menu.
- 3 Tap "OK" again to save the configuration, and jump to the next row.
- 4 Tap "M" to return to the previous page.

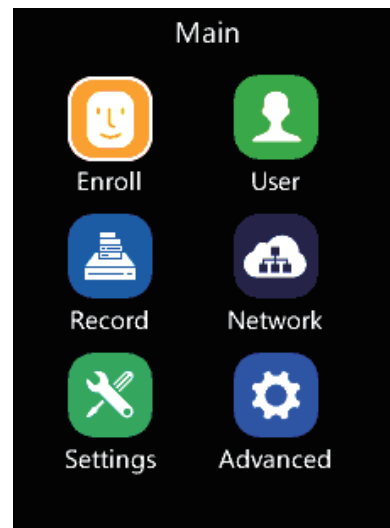
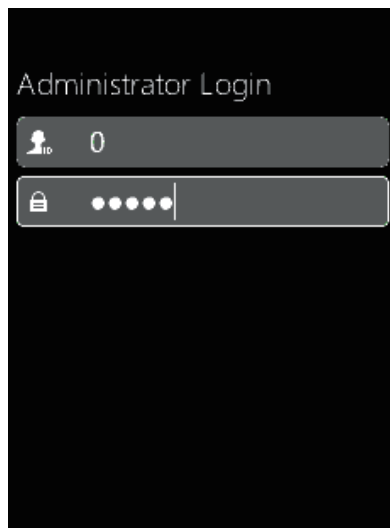

- W3 uses the keypad to input, and tap the numbers according to the function order on the screen.
- To ensure the security of the device, we recommend modifying the default administrator password the first time you use the W3. For detailed operating instructions, please see the section "Settings-Device".

Menu Option

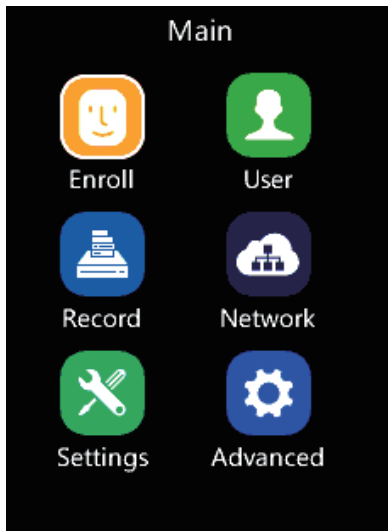

Enroll Face: Shortcut to register users' faces.

User: To Add, Modify, Delete, Search basic user information, and set Admin Level.

Record: Inquire about user records on the device.

Network: Set up the device network. Ethernet, Wi-Fi, Internet, Comm. Mode, and Cloud.

Settings: Device basic parameter settings. Include Device information, Time settings, Display, Basic Information, and self-test function.

Advanced: Include T&A (Time and Attendance), Application, Verify Mode, FN, and auto FN.

Enroll Face



- 1 Tap "M", then enter the admin ID and password to access the main menu.
- 2 On Main Page, tap the number "1" to access the enroll face interface.
- 3 Input the unique user identification number as User ID.
- 4 Tap "EnrollFace" to create a new user ID in the device.
- 5 Tap "OK" to continue to enroll the user's face.
- 6 Please adjust your face in the register area and stay until register success.

User

- 1 Tap "M" on the keypad, then enter the admin ID and password to access the main menu.
- 2 On Main Page, tap number "2" to access the user management interface.

Add User

- 1 On the User page, tap number “1” to access the Add User interface.
- 2 Input the user’s basic information on this page (Including User ID, Name, Password, Card ID, Mode, Admin, Group ID, Schedule, and Expiry date.)
- 3 Select the desired item, and then change the settings by tapping “↑/IN” or “↓/OUT”.
- 4 Tap “OK” to save the configuration, and jump to the next row.
- 5 Tap “M” to return to the previous page.

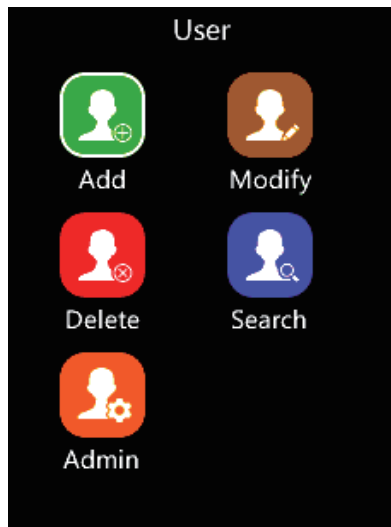

- **User ID:** The User ID is required and unique for each user.
- **User Name:** Input user name. (Tap the “Doorbell” to activate the input method and enter the username via the keypad)
- **User Password:** Input the maximum 6 digits as a password.
- **User RFID Card:** Swipe the RFID Card on the device’s RFID Card area, it will display the RFID Card number in the text bar.
- **Register Face:** Register the user’s face for user authentication.
- **Mode:** Select to set up the verify mode for the user, including System default, Face, ID->PW, and Card.
- **Admin:** The device supports different roles for the user.(Support 17 roles. The default is User) For detailed operating instructions, please see Section “Admin Level”.
- **Group ID:** The device supports 16 access control groups (The Default is Group 1, with whole-period access control permission).
- **Schedule:** Select the shift for the user.
- **Start and Expiry date:** Select the Start date and Expiry date for the user.



After the expiration date, employees will no longer have access control.

Modify User

Administrator can modify the registered user information.

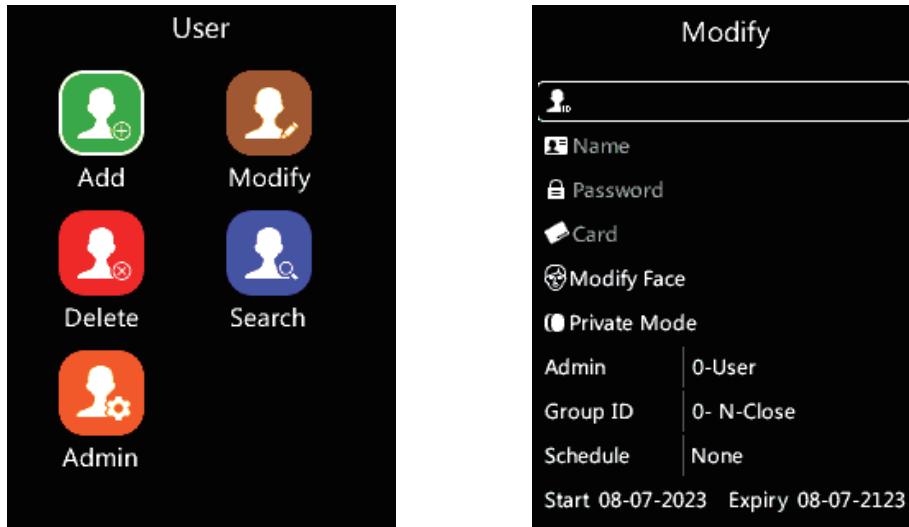

- 1 On the User page, tap number “2” to access the modify interface.
- 2 Input the registered user ID to modify the user information.
(Including the face template, mode, Admin, Group ID, schedule, and the Start & Expiry date.)
- 3 Select the desired item, and then change the settings by tapping “↑/IN” or “↓/OUT”.
- 4 Tap “OK” to save the configuration, and jump to the next row.
- 5 Tap “M” to return to the previous page.

Delete User

Administrator can delete user.

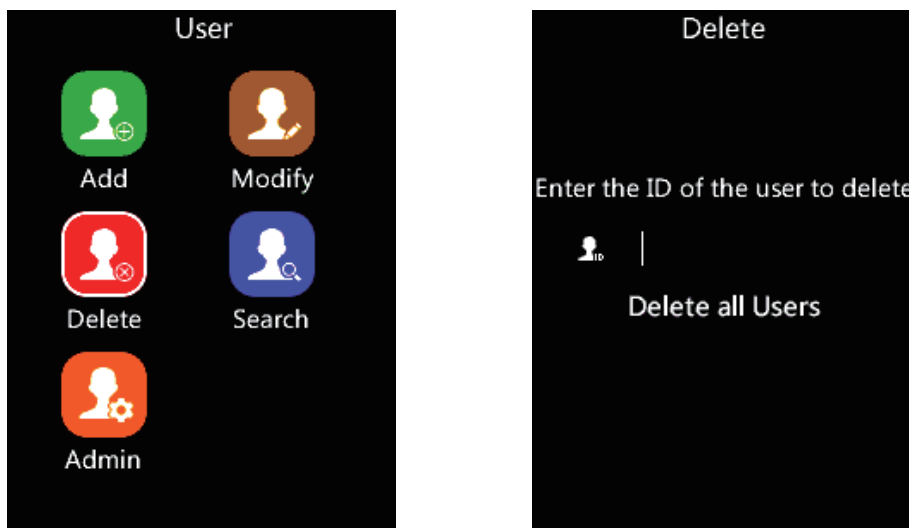

- 1 On the User page, tap number “4” to access the delete interface.
- 2 Input the User ID you want to delete and tap “OK” on the keypad to confirm the operation.
- 3 Tap “OK” to jump to “Delete all Users” option, and tap “OK” to delete all users.
- 4 Tap “M” to return to the previous page.



Tap “OK” to delete all Users, the device will ask for confirmation.
Input the super admin password to confirm the operation, default: “12345”.

Search User

Search users on this page.

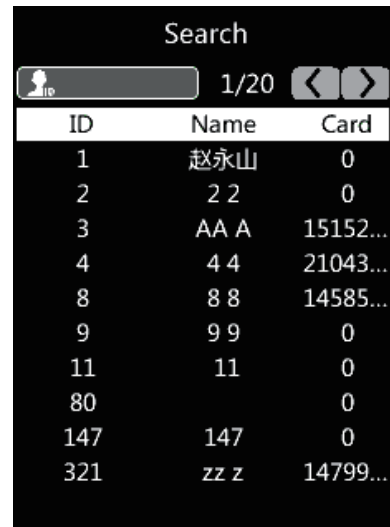
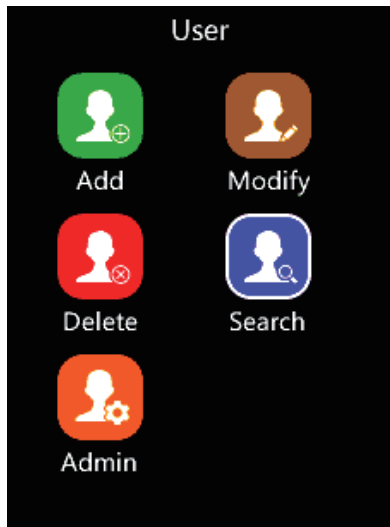

- 1 On the User page, tap number “5” to access the search user interface.
- 2 Input the User ID, and tap “OK” to search the user.
- 3 Tap “↑/IN” or “↓/OUT” to specify the user id for the search.
- 4 Tap “OK” to check the detail of the user.
- 5 Tap “M” to return to the previous page.

Admin Level

Set the Admin role privilege on this page.

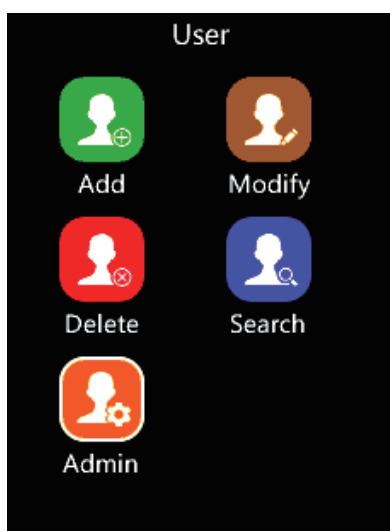

- 1 On the User page, tap number “7” to access the admin level interface.
- 2 Tap “↑/IN” or “↓/OUT” to select the Admin item. (Admin item from 1 to 16.)
- 3 Tap “OK” to enter the option.
- 4 Change the settings by tapping “↑/IN” or “↓/OUT”.
- 5 Tap “OK” to save the configuration.
- 6 Tap “M” to return to the previous page.

- 1 Tap "M", then enter the admin ID and password to access the main menu.
- 2 On the Main page, tap number "4" to access the Data interface.

Record

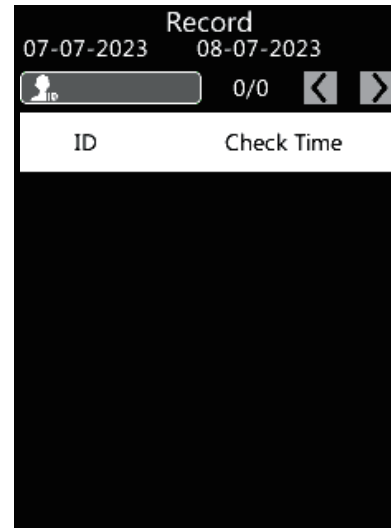
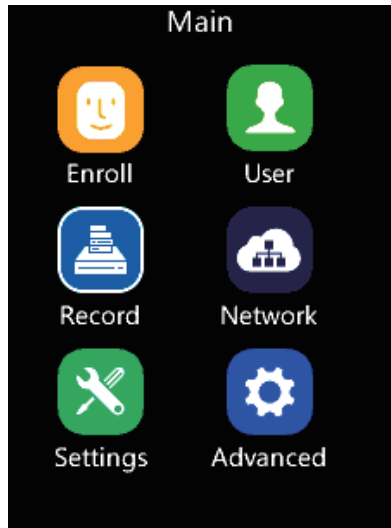

- 1 On the Data page, input the User ID, and tap "OK" to check the user's punch records.
- 2 Tap "↑/IN" or "↓/OUT" to select the page, and you can review the attendance records based on the date.
- 3 Tap "M" to return to the previous page.

Network Settings

- 1 Tap "M", then enter the admin ID and password to access the main menu.
- 2 On the Main page, tap number "5" to access the network configuration interface.

Ethernet

Please make sure that the network cable is already connected to the W3.

Set up the IP address for the device via the network cable.

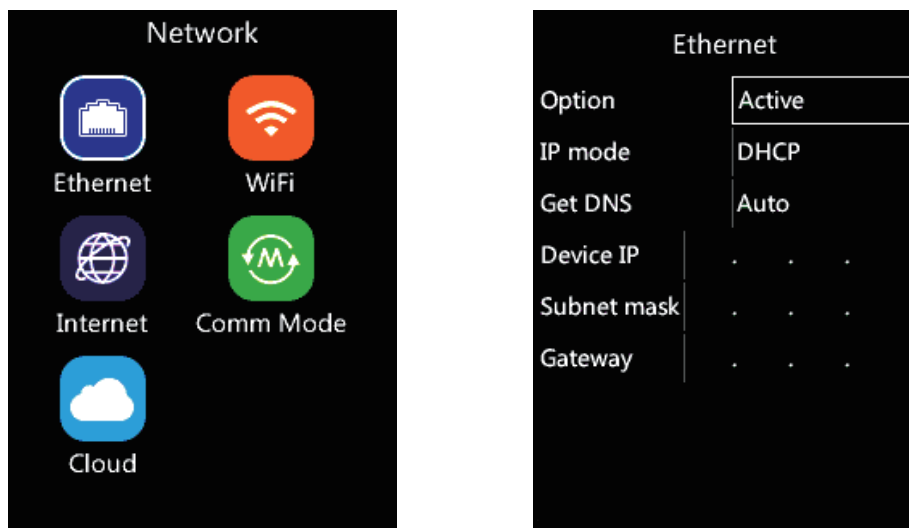

- 1 On the Network page, tap number "1" to access the Ethernet interface.
- 2 Select the desired item, and tap "OK" to enter.
- 3 Change the settings by tapping "↑/IN" or "↓/OUT", tap "OK" to save the configuration.
- 4 Tap "M" to return to the previous page.

Option: Active or inactive the network communication based on cable.

IP mode: Select "Static" for fixed IP or "DHCP" for dynamic IP mode.

Static: Fixed IP address that doesn't change. In static IP mode, you need to manually enter the IP address of the device, please contact the system administrator to obtain the valid IP address.

DHCP: DHCP is a network server that will automatically provide and assigns an IP address, default gateway, and other network parameters to client devices. If the DHCP is disabled, the user can modify the Device IP, Subnet mask and Gateway.



Please contact your system administrator or IT responsible for more details.

Get DNS: Select between "Manual" or "Auto".

Manual: Get the DNS by set up in the "Internet" option.

Auto: Get the DNS by the local network system.

Device IP: Set the device IP manually in case of Static IP mode.

Subnet Mask: Set the device Subnet mask manually in case of Static IP mode.

Gateway: Set the device Gateway manually in case of Static IP mode.

WiFi

Set up the wireless connection for the device.

Wlan Mode: Two modes, you can choose WiFi mode or AP mode.

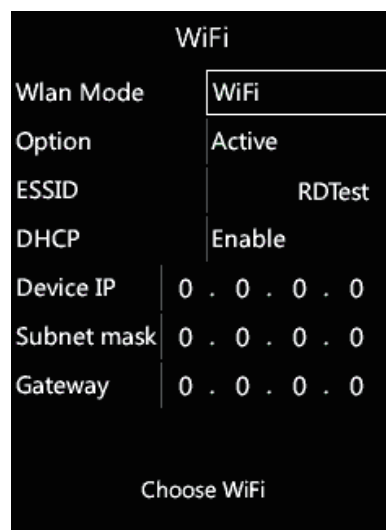
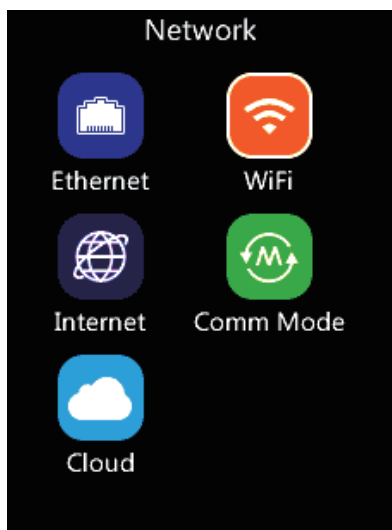

AP Mode

- 1 On the Network page, tap number “2” to access the WiFi settings interface.
- 2 Select the “Wlan Mode”, and tap “OK”.
- 3 Change the settings by tapping “↑/IN” or “↓/OUT”.
- 4 Tap “OK” to save the configuration.
- 5 Tap “M” to return to the previous page.

AP: The access point function creates a local area wireless network. Connect a PC or smartphone to the W3 WIFI AP and input its default IP address (192.168.0.218) in the browser to login into the W3 web server to manage the device.

AP Mode: Default / Custom. Insert the device’s WIFI AP SSID name.

Default Name: Display default WIFI AP ESSID name.

Custom Name: Display custom WIFI AP ESSID name.

AP Password: Set up AP communication password.

WiFi Mode

- 1 On the Network page, tap number “2” to access the WiFi settings interface.
- 2 Select the “Wlan Mode”, and tap “OK” to change the mode.
- 3 Change the settings by tapping “↑/IN” or “↓/OUT”.

WiFi Mode: The device will use WiFi communication.

Option: Active / Inactive network WiFi communication based on WiFi.

ESSID: Display the connected WiFi ESSID.

Retrieve IP mode: Select “Static” for fixed IP or “DHCP” for dynamic IP mode.

Device IP: Set the device IP manually in case of Static IP mode.

Subnet mask: Set the device Subnet mask manually in case of Static IP mode.

Gateway: Set the device Gateway manually in case of Static IP mode.

Network Settings

Choose WiFi: Select the WiFi name in ESSID and input the password, then select “Done” on this page to connect.

Add WiFi: Add a new WiFi, modify the WiFi ESSID manually and click “done” to start the WiFi authentication process.

Internet

- 1 On the Network page, tap number “4” to access the device communicate method select interface.
- 2 Select the “WAN Mode”, and tap “OK” to change the mode.
- 3 Change the settings by tapping “↑/IN” or “↓/OUT”.
- 4 Tap “OK” to save the configuration.
- 5 Tap “M” to return to the previous page.

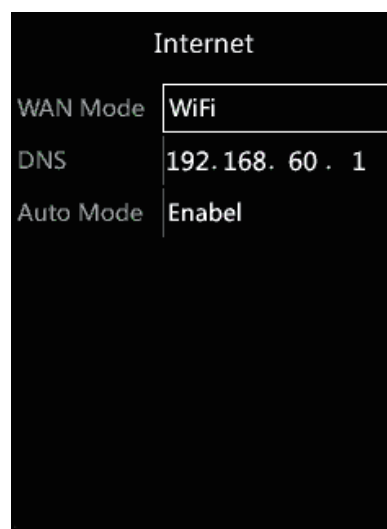
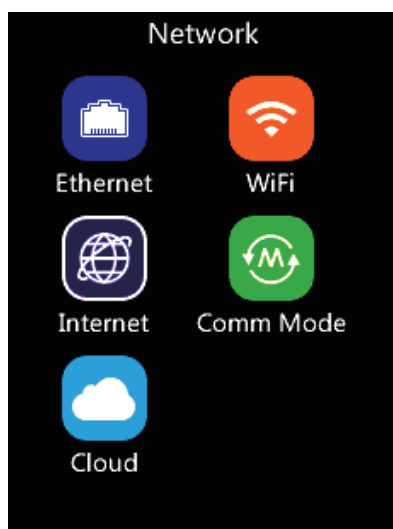

If you have already connected and configured the device by Ethernet, we suggest select the Ethernet option. If you have already connected and configured the device by WIFI, we suggest select the Wi-Fi option. If you have already connected and configured the device both ways, please keep the Auto Mode as Enable.

DNS: Please define the DNS address manually here if you choose the manual way to set up DNS in Ethernet and Wi-Fi configuration option.

Comm. Mode

- 1 On the Network page, tap number “5” to access the communication mode setting interface.
- 2 Select the “Comm mode”, and tap “OK” to change the mode.
- 3 Change the settings by tapping “↑/IN” or “↓/OUT”.
- 4 Tap “OK” to save the configuration, and jump to next row.
- 5 Tap “M” to return to the previous page.

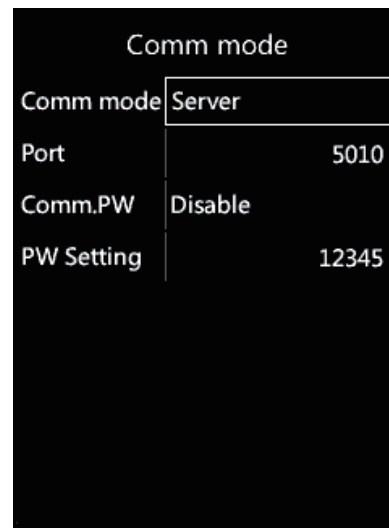
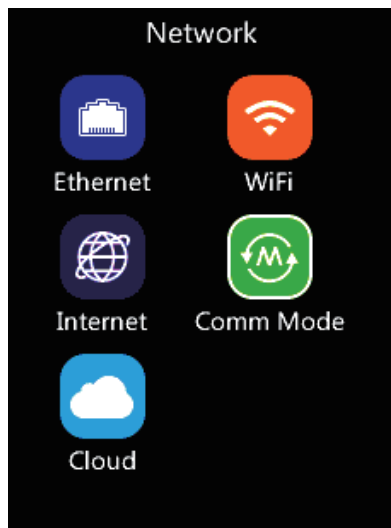

Comm mode: Server Mode / Client Mode

Server Mode: The device works as a Server. It sends their records to the software when the software sends a command. In this mode, any PC on the same network can connect to the device.

Client Mode: The device works as a Client terminal, The device will automatically send the records to a specified server.

Comm. PW: Enable/Disable the network communication password.

PW Setting: Setup communication password.



The port can be changed according to your needs.
Make sure to modify the communication port of the software synchronously.

Cloud

- 1 On the Network page, tap number “7” to access the Cloud settings interface.
- 2 Select the “Active Cloud”, and tap “OK” to change the setting.
- 3 Change the settings by tapping “↑/IN” or “↓/OUT”.
- 4 Tap “OK” to save the configuration, and jump to the next row.
- 5 Tap “M” to return to the previous page.

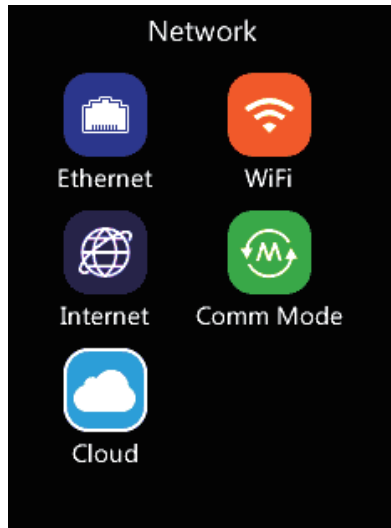

The W3 device supports Anviz CrossChex Cloud System communication. For more details, please refer to the Cloud menu.

Active Cloud: Open / Close.

Company ID: Input the Company ID registered in your CrossChex Cloud account.

Cloud Password: Input the password created in your CrossChex Cloud account.

Network Test: Select to test the connectivity between the device and the CrossChex Cloud.

- 1 Tap "M", then enter the admin ID and password to access the main menu.
- 2 On the Main page, tap number "7" to access the settings interface.

Device

View the Device ID, Admin PIN Code, Web activation and web port information.

- 1 On the Settings page, tap number "1" to access the device information interface.
- 2 Tap "OK" to save the configuration, and jump to the next row.
- 3 Tap "M" to return to the previous page.

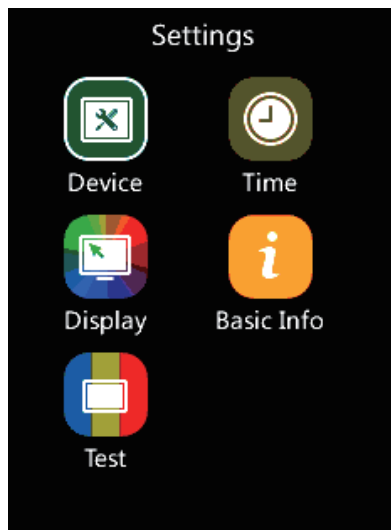

Device ID: Insert the Device ID (default: 1). In the same network, each device must have a unique ID.

Admin PIN Code: Set the Administrator password to log into the internal device menu (default: 12345)

Web Activation: Enable/Disable the device management by the web interface.

Web port: Select the web port for web management (default: 80).

Factory Reset: Set the device in factory mode.



Caution: This procedure will delete all the users and records from the device.

Restart: Reboots the device, keeping stored all the existing information.

Time

Set date and time, and Set the mode to accurate the time.

- 1 On the Settings page, tap number “1” to access Time interface.
- 2 Select the desired item and tap “OK”, then change the settings by tapping “↑/IN” or “↓/OUT”.
- 3 Tap “OK” to save the configuration, and jump to the next row.
- 4 Tap “M” to return to the previous page.

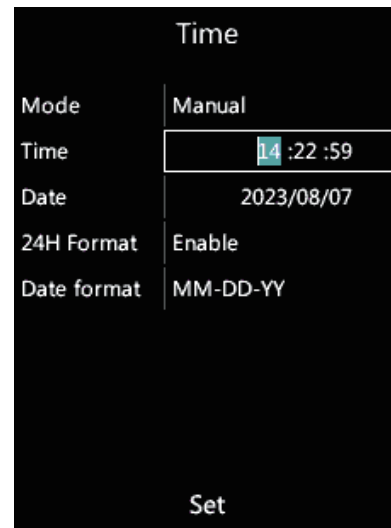
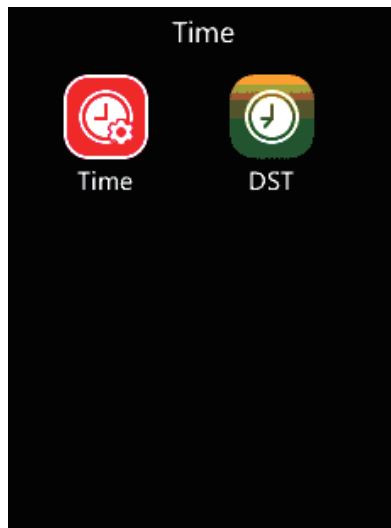

Mode: There are two modes to set the time:

Auto: Automatically adjust the device date/time according to the NTP server.

(Need to input an available NTP server IP address manually).

Manual: Adjust the device date/time manually.

Time: Only set the time manually in manual mode.

Date: Only set the date manually in manual mode.

24H format: Set the time format for the device. (12 hr/24 hr)

Date format: Set the date format for the device. (YY-MM-DD, MM-DD-YY, DD-MM-YY)

DST

DST: Daylight-saving time settings. The Daylight-saving time is a manual method to set the local area time zone Deviation, according to where the device is located.

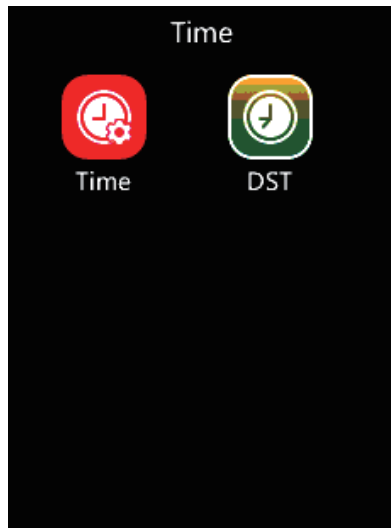

- 1 On the Settings page, tap number "2" to access the Time settings interface, then tap number "2".
- 2 Select the desired item and tap "OK" then change the settings by tapping "↑/IN" or "↓/OUT".
- 3 Tap "OK" to save the configuration, and jump to the next row.
- 4 Tap "M" to return to the previous page.

Display

You can change the display settings of the device.

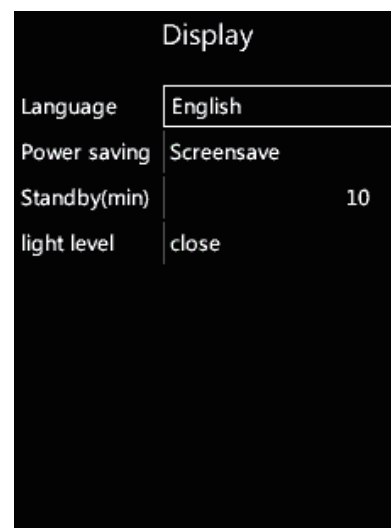
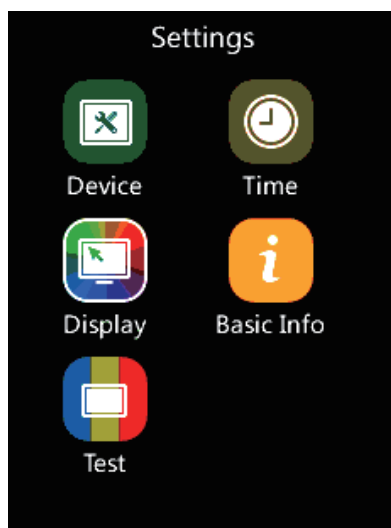

- 1 On the Settings page, tap number "4" to access the device display settings interface.
- 2 Select the desired item and tap "OK" then change the settings by tapping "↑/IN" or "↓/OUT".
- 3 Tap "OK" to save the configuration, and jump to the next row.
- 4 Tap "M" to return to the previous page.

Language: Select to switch the system language.

Power saving: Energy saving display settings.

Standby(min): Input the numbers to set the standby period of the device.

Light Level: Set the LED light brightness (off, low, medium, high)

Basic Info

You can view the device Serial number, employee No., card count, face No., log, firmware version, kernel version and file system version.

- 1 On the Settings page, tap number “5” to access the device’s basic information interface.
- 2 Select the desired item and tap “OK” then change the settings by tapping “↑/IN” or “↓/OUT”.
- 3 Tap “OK” to save the configuration, and jump to the next row.
- 4 Tap “M” to return to the previous page.

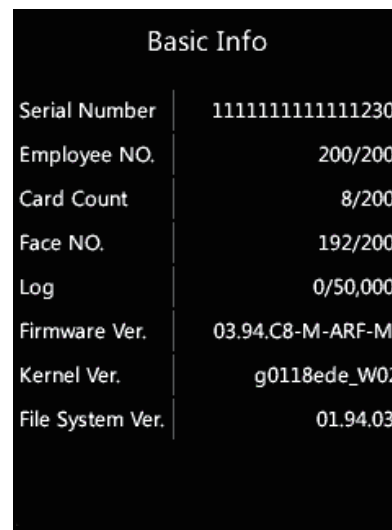
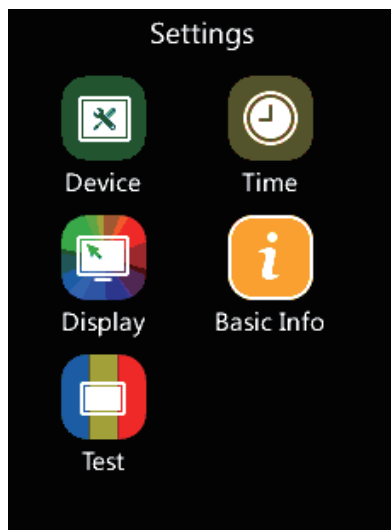

Basic Info	
Serial Number	111111111111230
Employee NO.	200/200
Card Count	8/200
Face NO.	192/200
Log	0/50,000
Firmware Ver.	03.94.C8-M-ARF-MI
Kernel Ver.	g0118ede_W02
File System Ver.	01.94.03

Serial Number: the s/n of this device.

Employee No: Number of employees stored on the device memory.

Card Count: Number of RFID cards stored on the device memory

Face No: Number of facial templates stored on the device memory.

Log: Number of log records stored on the device memory.

Firmware Ver: The current firmware version of this device.

Kernel Ver: The current kernel version of this device.

File System Ver: The current file system version of this device.

Test

On the Settings page, tap number “7” to access the device self-test interface.

In this mode, the user can test the device’s LCD display and keypad function control.

On the Main page, tap number “8” to access the Advance settings interface.

T&A (Time Attendance Settings)

- 1 On the Advanced page, tap number “1” to access the Time Attendance settings of the device.
- 2 Select the desired item and tap “OK” then change the settings by tapping “↑/IN” or “↓/OUT”.
- 3 Tap “OK” to save the configuration, and jump to the next row.
- 4 Tap “M” to return to the previous page.

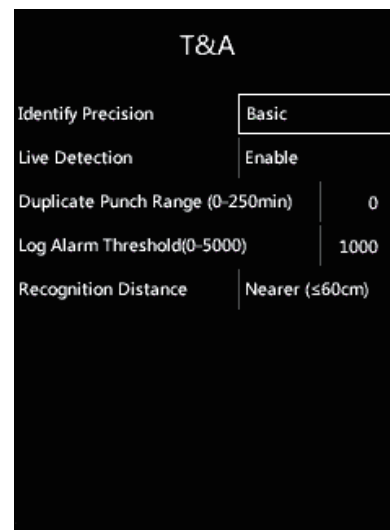
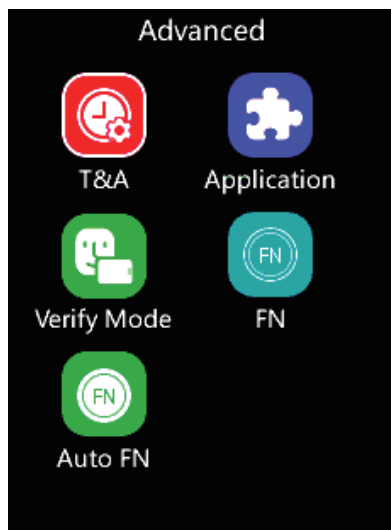

Identify Precision: Facial template comparison accuracy. (Default: Basic)

Live Detection: Biological Live Identification, Enable or Disable the capacity to recognize live faces (Default: Enable)

Duplicate Punch Range(0-250min): Set the time interval for repeated punching of the same employee to prevent the system from generating duplicate punching records. (Default: 0)

Log Alarm Threshold(0-5000): The device will emit an alarm when the log records reach the number inserted on this field to inform the log memory is almost full. (Default: 0).

Recognition Distance: Chosen distance to validate a check-in or check-out record. (Default: Nearer≤60cm)

Application

On the Advanced page, tap number “2” to access the Application interface.

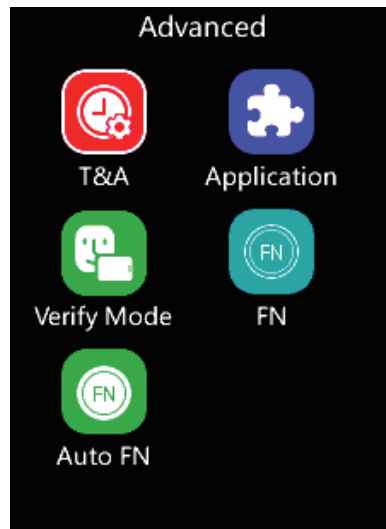

Access (Access Control Settings)

- 1 On the Application page, tap number “1” to access the Access Control Settings interface.
- 2 Select the desired item and tap “OK” then change the settings by tapping “↑/IN” or “↓/OUT”.
- 3 Tap “OK” to save the configuration, and jump to the next row.
- 4 Tap “M” to return to the previous page.

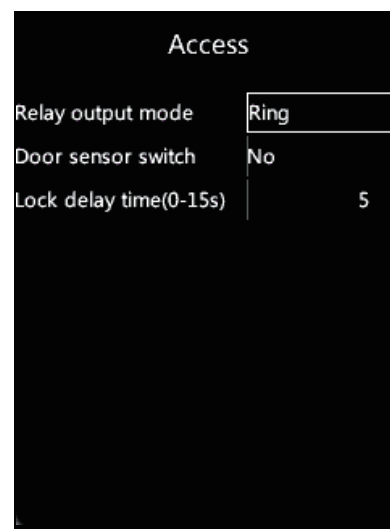
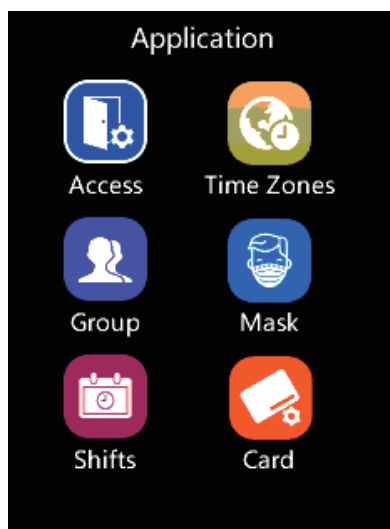

Relay output mode: Define the device relay signal function.

(Door or Scheduled Ring or None)

Door sensor switch: Active the door sensor alarm. Setup time range from 1~20 seconds.

(Default: No).

Lock delay time(0-15s): Set up the relay delay time of 0-15 seconds.

(Default: 5 seconds)

Time Zones

At this interface, you can set rules for access control restriction according to the weekday and time. Can create up to 32 different access rules, they can be assigned to a user group. (section Group)

- 1 On the Application page, tap number “2” to access the Time Zones Settings interface.
- 2 Select the desired item and tap “OK” then change the settings by tapping “↑/IN” or “↓/OUT”.
- 3 Tap “OK” to save the configuration, and jump to the next row.
- 4 Tap “M” to return to the previous page.

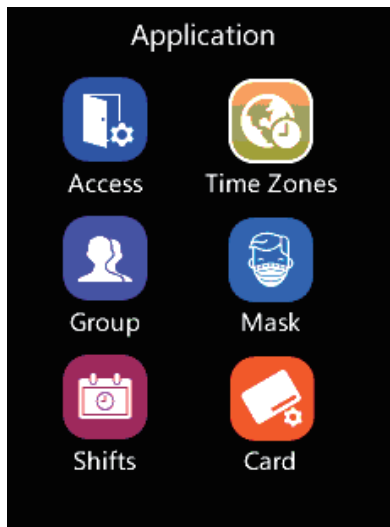

Group

On the Application page, tap number “4” to access the Group Settings interface.

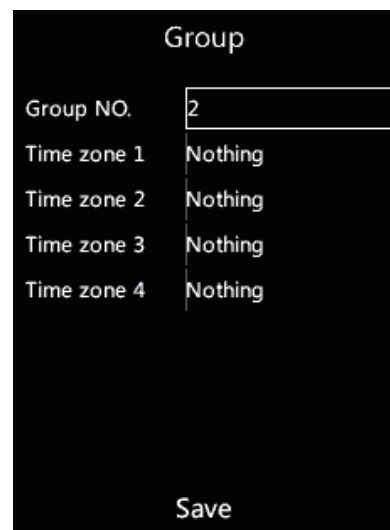
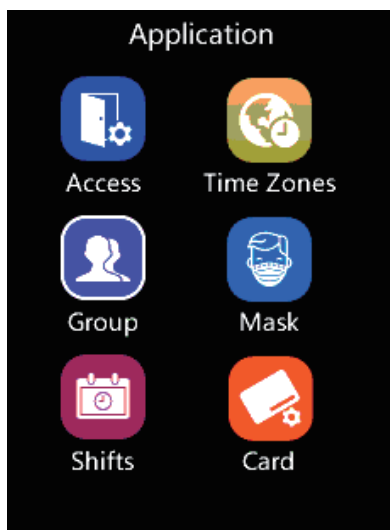

Group NO.: Select the Group number and modify and add the previously configured time zone(s) in there.

Mask

- 1 On the Application page, tap number “5” to access the Mask Settings interface.
- 2 Select the desired item and tap “OK” then change the settings by tapping “↑/IN” or “↓/OUT”.
- 3 Tap “OK” to save the configuration, and jump to the next row.
- 4 Tap “M” to return to the previous page.

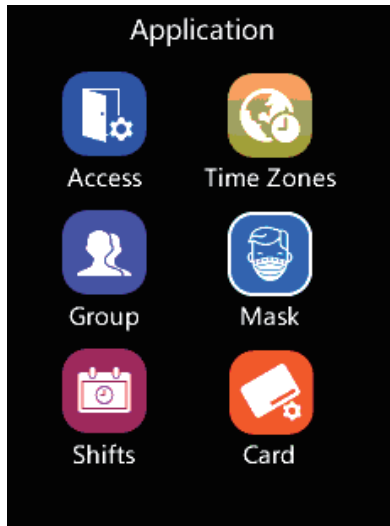

- Each user group can accept up to 4 different time zones.
- Make sure to set the user group correctly when adding/modifying a user. (section user)
- Click “Save” to store operation.

Mask Detection: OFF/Only Alarm/Access Control.

OFF: Disable the Mask detection function under the mask detection face recognition algorithm.

Only Alarm: The device will alarm out with voice and display an alarm prompt dialog box on the device screen when a user without a mask is detected.

Access Control: The device will not trigger the relay to open the door when a user without a mask is detected.

Mask Alarm: Enable/Disable the voice alarm in the device.

Shifts

Set up the shift starting time and end time.

The terminal will follow the shift schedule to calculate employees' time attendance records and export by Excel or display in the web server.

- 1 On the Application page, tap number "7" to access the Shift Schedule Settings interface.
- 2 Select the desired item and tap "OK" then change the settings by tapping "↑/IN" or "↓/OUT".
- 3 Tap "OK" to save the configuration, and jump to the next row.
- 4 Tap "M" to return to the previous page.

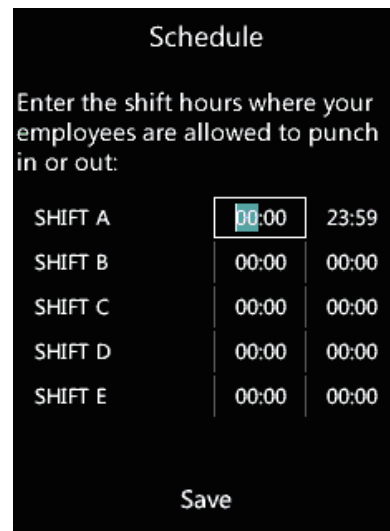
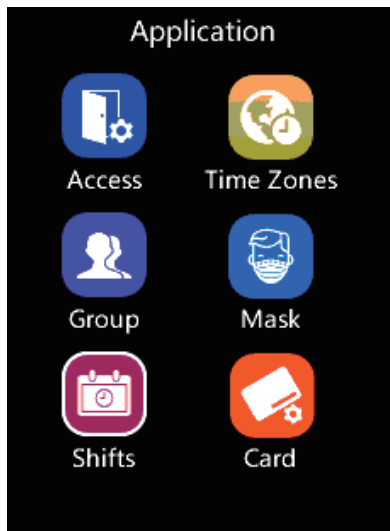

Card

On the Application page, tap number "8" to access the Card Settings interface.

Show Card: BE-4Byte.

Verify Valid Bytes: BE-4Byte.

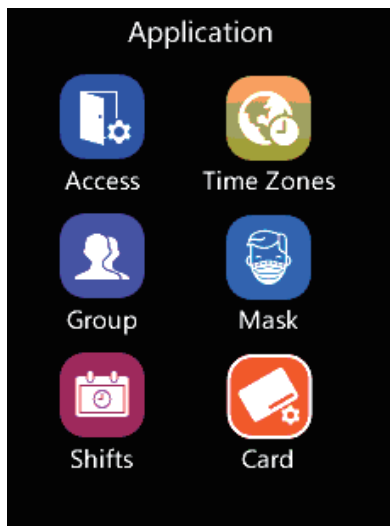

Verify Mode

- 1 On the Advanced page, tap number “4” to access the Verify Mode Settings interface.
- 2 Select the desired item and tap “OK” then change the settings by tapping “↑/IN” or “↓/OUT”.
- 3 Tap “OK” to save the configuration, and jump to the next row.
- 4 Tap “M” to return to the previous page.

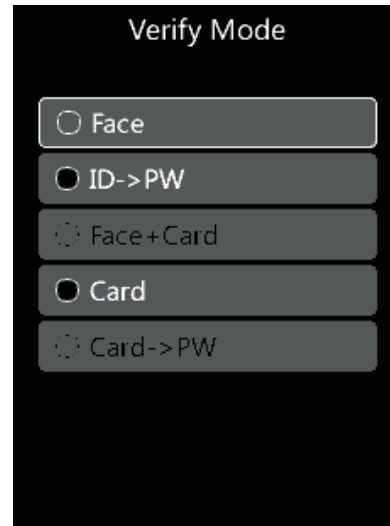
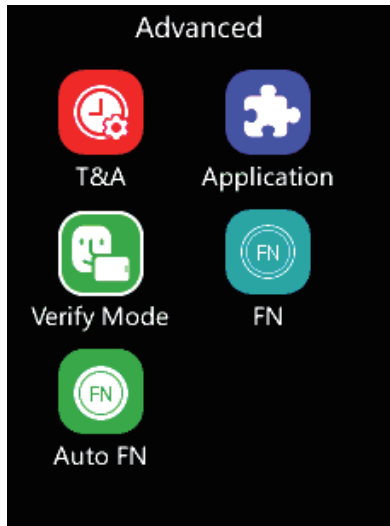

PW: Means password.

ID: Means User registered number.

FN

On the Advanced page, tap number “5” to access the FN Settings interface.

At this Interface it's possible to add or modify time attendance status and its names.

Auto FN

On the Advanced page, tap number “7” to access the Auto FN Settings interface.

At this Interface it's possible to generate specific records according to date and time.

Example: Records from 07:00 am to 10:00 am on Monday will be always considered IN.

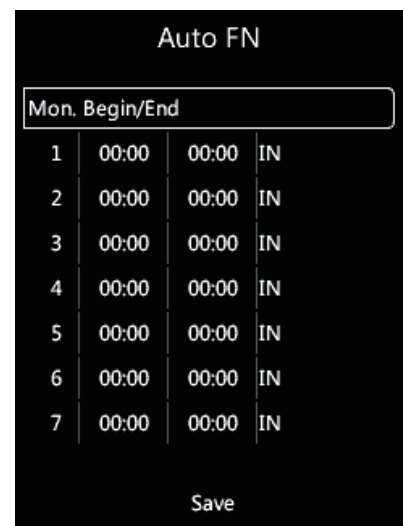
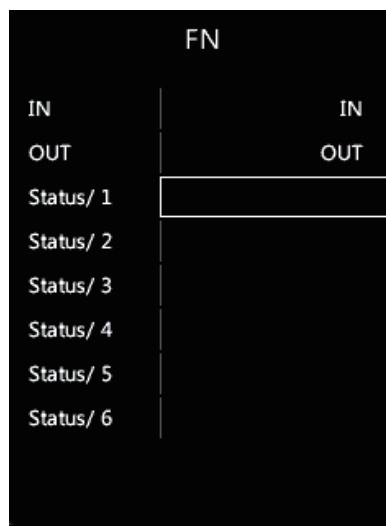
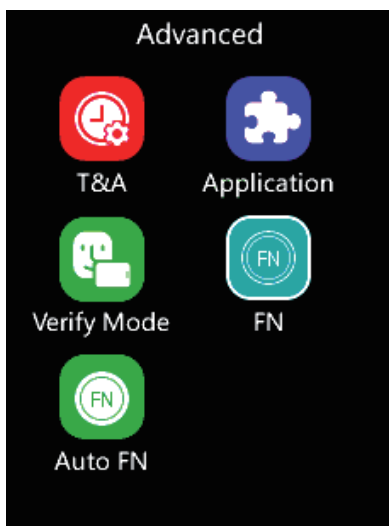



In order to protect the environment, Anviz has decided to go "CD Free" campaign since June 1st 2019. We will provide QR code for you to download the electronic documents to make sure that you understand how to install and use Anviz devices.



Scan for Software
CrossChex Standard

Before using all Anviz products, please read all applicable terms, rules, policies and usage provisions found at <https://www.anviz.com/privacypolicy> and <https://www.anviz.com/anviz-biometric-data-retention-policy>. By using your Anviz, you agree to be bound by the Anviz Privacy Policy.

Anviz brand and product are trademarked and protected under law of the United States.

Unauthorized use is prohibited.

For more information visit www.anviz.com, or email marketing@anviz.com for further help.

©2023 Anviz Global Inc. All Rights Reserved.

Warranty and Service

Anviz warrants that the hardware will be free from material defects in materials and workmanship and will substantially conform to the applicable Documentation in effect as of the date of manufacture for a period of three (3) years from the date of shipment by Anviz (“Warranty Period”).

For more warranty information about this product, please visit the link below:

www.anviz.com/warranty-policy

Shipping Fees

The End Customer is responsible for the shipping fee for sending the product to Anviz, and the return shipping fee for sending the product back to customers is borne by Anviz (paying for one-way shipping).

However, if the device is considered as No Fault Found, which means the device works normally, the returning shipment, too, is borne by End Customer (paying for round-trip shipping).

Return Merchandise Authorization (“RMA”) Process

Please fill out the Anviz RMA request form online

[https:// www.anviz.com/form/rma.html](https://www.anviz.com/form/rma.html)

and ask the technical support engineer for an RMA number.

You will receive the RMA confirmation with the RMA number in 72 hours, after receiving an RMA number, please send the product in question to Anviz by following the Anviz shipment guide.

- When the inspection of the product is completed, you receive an RMA report from the technical support engineer. Anviz decides to repair or replace parts after user confirmation.
- When the repair is completed, Anviz notifies the user of that and sends the product back to you.
- An RMA number is valid for two months from the date of its issuance.
- An RMA number that is more than two months old is null and void, and in such a case, you need to get a new RMA number from Anviz’s technical support engineer.
- Products without a registered RMA number will not be repaired.
- Products shipped without an RMA number may be returned, and Anviz will not be held responsible for any loss or other damage caused by this.