

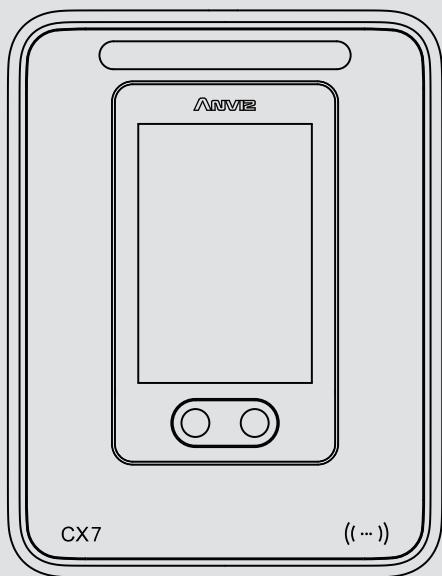









CX7

Touchless Face Recognition Time Clock



User Guide

CONTENTS

| | | |
|--|---|----|
|  | Step 1 Create CrossChex Cloud Account | 4 |
|  | Step 2 Activate your CX7 Time Clock | 7 |
|  | Step 3 Change the Time Clock default Password | 11 |
|  | Step 4 Add Department | 12 |
|  | Step 5 Device Management | 13 |
|  | Step 6 Add Employee | 14 |
|  | Step 7 Device Wall Mount | 20 |
|  | Step 8 CX7 Introduction | 21 |
|  | Step 9 Device Operation | 22 |
|  | Warranty Warranty & RMA | 30 |

Before Starting

Hardware Safety Instructions

Observe the following instructions to use the product safely and prevent any risk of injury or property damage.

- Do not use oily water or sharp objects to stain or damage the display screen.
- Fragile parts are used in the equipment, please avoid operations such as falling, crashing, bending or heavily pressing.
- The optimal working environment of CX7 is indoor. The device function fully under temperature: $-10^{\circ}\text{C}\sim 50^{\circ}\text{C}$ ($14^{\circ}\text{F}\sim 122^{\circ}\text{F}$), The best performance is between: $15^{\circ}\text{C}\sim 32^{\circ}\text{C}$ ($59^{\circ}\text{F}\sim 89.6^{\circ}\text{F}$). The device will be less effective if exceeds these ranges.
- Please gently wipe the screen and panel with soft materials. Avoid scrubbing with water or detergent.
- The recommended power of CX7 terminal is DC 12V ~ 2A. The device will function less effective in case the power supply cable extends too long.
- CX7 will turn on infrared filling light in case no ambient light enough.

ANVIZ Terms & Policies

Before using all ANVIZ products, please read all applicable terms rules, policies and usage provisions found at www.anviz.com/privacypolicy and www.anviz.com/anviz-biometric-data-retention-policy.

By using your ANVIZ products, you agree to be bound by the ANVIZ Terms & Policies.

Packing List

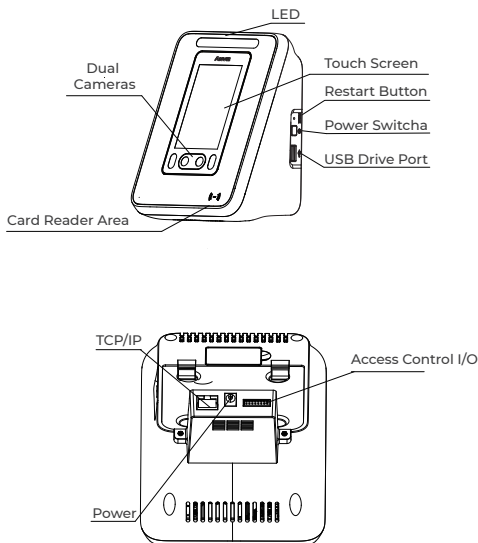

Step 1 Create CrossChex Cloud Account

Before you can set up your new Time Clock, you will need to set up your CrossChex Cloud Account.

CrossChex Cloud is a cloud-based time and attendance management system, you can use it anywhere over internet with any internet browser.

Open your web browser and visit <https://us.crosschexcloud.com/register> then follow the prompts.

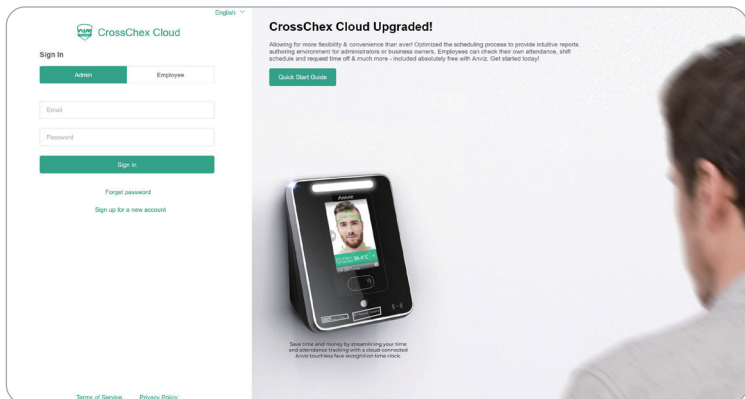

Please fill the E-mail and Password fields.

We suggest read Terms of Service and Privacy Policy.

Then fill the “Agree to Anviz Global Terms of Service and Privacy Policy.” box to continue.

Click “**Register**” to proceed.

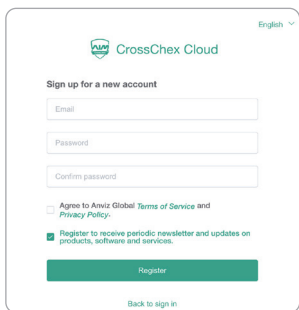

Notice:

“Register to receive periodic newsletter and updates on products, software and services” is optional, feel free to choose it or not.

Use the same e-mail and address you Created to Log In

1/3

Hey! Help us create the best experience for you!



Organization Information



Your Details



Date & Time



Company Logo

Upload Logo

*We recommend using a PNG or JPG image and dimensions of 128 x 128 pixels.

Organization Name

Industry



Organization Information



Your Details



Date & Time

[← Back](#)

First Name

Last Name

Job Title

Country

Organization Information Your Details Date & Time

← Back

Time Zone

(UTC +800) Australian Western Standard Time, Beijing Time

Date Format

mm/dd/yyyy

Time Format

12h

Done

CrossChex Cloud will forward you to the pre-settings pages to fill the basic information. Please make sure to fill them correctly, especially the Time Zone field, it will be used as reference to synchronize your Time Clock devices with the correct date and time.

CrossChex Cloud Dashboard Organization Attendance Record Settings

Company

General

Role

Holiday

LOGO

Upload Logo

*We recommend using a PNG or JPG image and dimensions of 120 x 120 pixels

Company ID: 10000054

Cloud Password: ****

Company Name: Anviz

Address:

Country: United States

State: Alabama

You can always modify the information set on pre-settings step at the Settings tab.

Please save your account's **Company ID** and **Cloud Password**, we'll use them to connect the CX7 terminal with the CrossChex Cloud system.

Step 2 Activate your CX7 Time Clock

The CX7 can be connected with the internet by Ethernet cable (LAN) and WiFi.

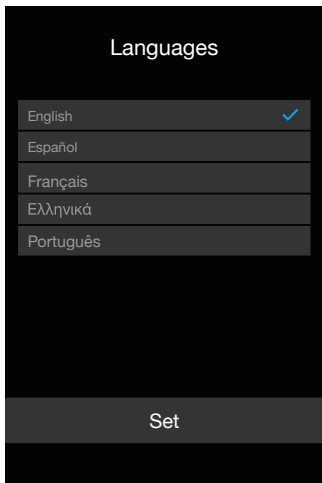

I . Plug your Time Clock into a power outlet to power on the terminal.

II . Choose your preferred language by clicking on the time clock display, then click "**Set**" to save the selected option and move to the next step.

2.1 Network Setup by Cable (LAN)

- 1 Connect a LAN cable between your clock and a router with internet access.
- 2 Select "**Ethernet**" as the preferred the network mode.
- 3 Select "**DHCP**" in the IP mode to automatic get the network information or fill the correct network information in the terminal (IP address, Subnet mask and Gateway) to connect with internet. Click "**Set**" to proceed.

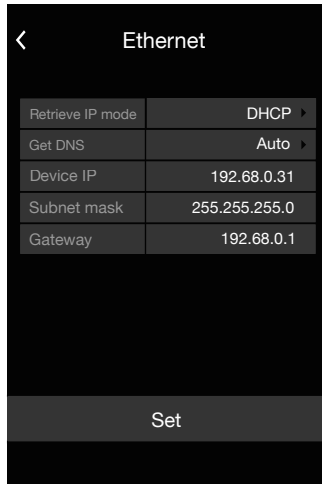
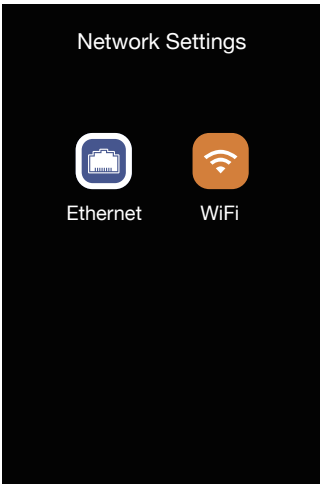

2.2 Wireless Network Setup (WiFi)

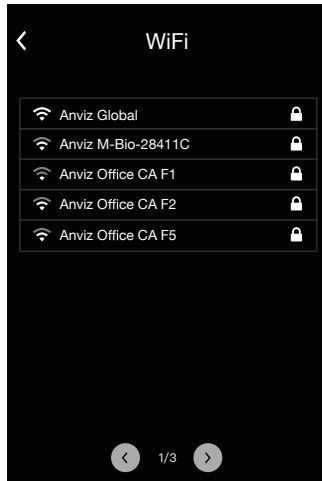
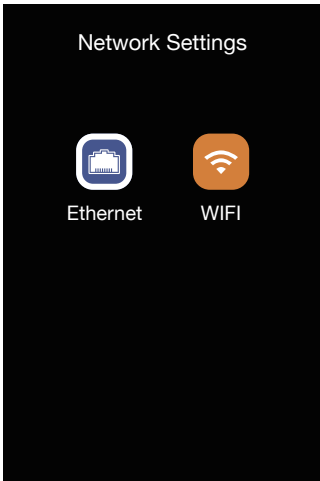

1 Select the preferred WiFi network (SSID).

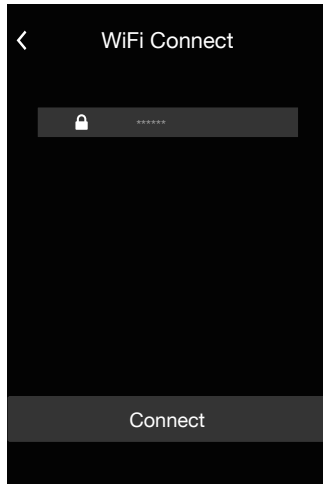
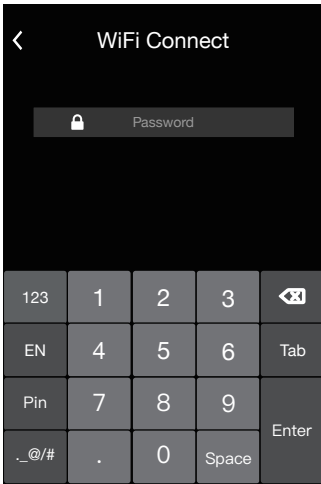

2 Insert the WIFI password and click “Connect” to finish the WiFi setup. After WiFi connected the terminal will to next proceed. Network Setting

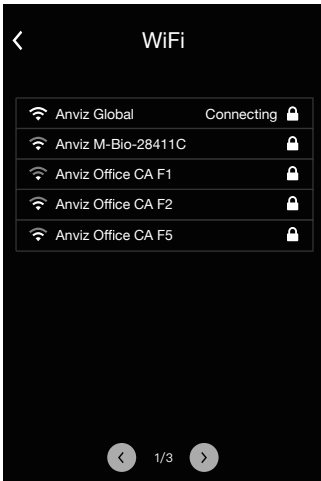

Notice:

Please make sure the Network setup correct. The terminal is necessary to connect with internet. Or click < back to "Network" setup.

2.3 Cloud Setup

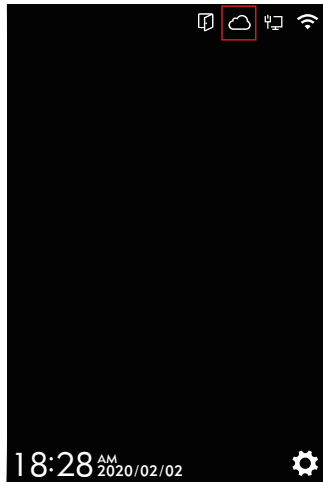
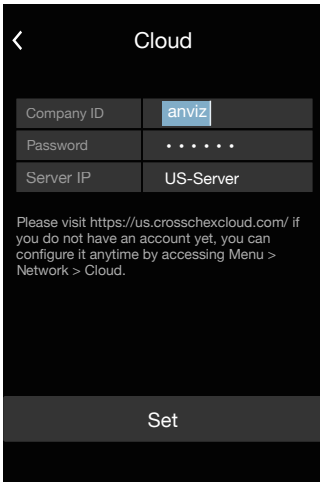

1 Fill the **Company ID** and **Password** in the terminal. click “Set” to proceed.

(The Company ID and Password can be found in the Settings tab of your CrossChex Cloud Account. If you do not have an account yet, please check Step 1 of this manual.)

2 Please check your device ´s Cloud Icon at the top of the screen and the device will be shown at Device tab of your CrossChex Cloud.

3 You can continue tap  on the screen to device menu by input the default Admin ID and Password.

Default Admin ID: 0 Password: 12345

The more Time Cloud Operations please check **Device Operation** of this manual.

Notice: Please change the default password from the Cloud software for security concerns.

Step 3 Change the Time Clock default Password

1. Select the Time Clock in the Device Tab of your CrossChex Cloud and click “Edit” to change the device Admin Pin Code.
2. The Admin Pin Code is a numeric-only password at maximum 6 digits.

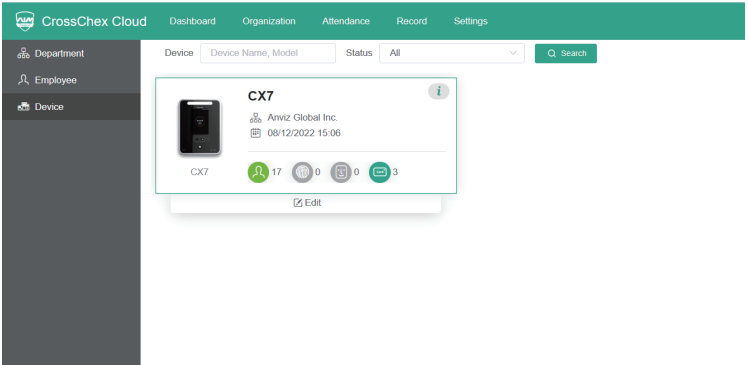

The 'Edit Device' modal form contains the following fields:

- Name: CX7
- Dept.: Anviz Global Inc.
- Language: English
- Voice: 1
- Admin PIN Code: ***** (highlighted with a red box)

At the bottom of the modal, there are three buttons: 'Delete Terminal', 'Cancel', and 'Confirm'.

Step 4 Add Department

Departments are used to group users and time clock terminals together within the Cloud system.

Login the cloud system, you will be signed in at the main page, the **Dashboard**.

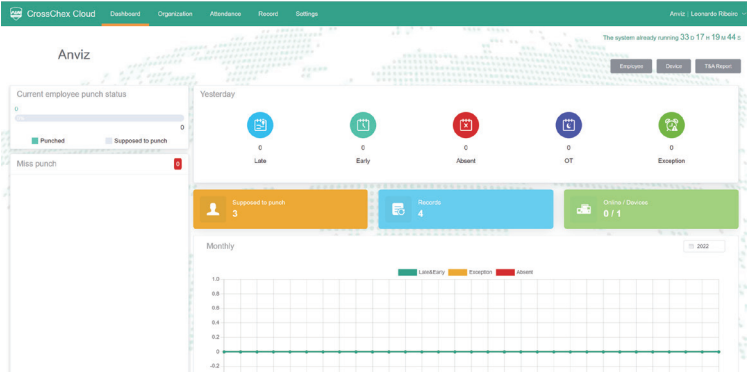

1 At the top bar, click **“Organization”**, you’ll be automatically forwarded to the Department area of the software.

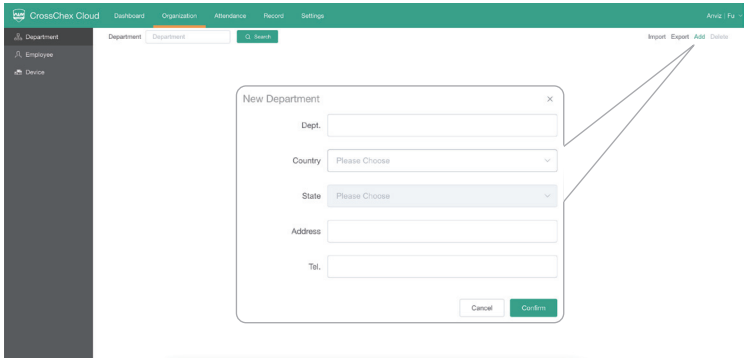

2 Click **“Add”** to create a new department, then insert the new department’s information. Click **“Confirm”** to save it.

3 You can always edit the already created departments or delete them by using the checking boxes at their respective left side, and the buttons on the right side.

Notice:

After creating departments you will be able to assign device(s) to a respective department and give local permission for users and employees.

Be careful when deleting departments with employees and/or devices assigned at them, it can affect your system reports when modifying them wrongly.

Step 5 Device Management

In the device management area it's possible to check hardware information and assign them to the created departments at **Step 4**.

At the top bar, click "**Organization**", and "**Device**". You'll be able to see your connected devices

The screenshot shows the CrossChex Cloud interface. The top navigation bar includes 'CrossChex Cloud', 'Dashboard', 'Organization', 'Attendance', 'Record', and 'Settings'. The left sidebar has 'Department', 'Employee', and 'Device' options. The main content area is titled 'Device' and has a search bar. A table lists devices, with one device 'CX7' selected. Below the device card, there are icons for users (4), records (0), and settings (2), along with an 'Edit' button. A callout box shows the 'Edit Device' form with fields for Name (CX7), Dept. (Dep 1), Language (English), and Voice (4). Buttons for 'Cancel Terminal', 'Cancel', and 'Confirm' are at the bottom.

Whenever a new device is added, it will be automatically assigned at the main department. Select the terminal icon and click "**Edit**", then choose the respective department you want to assign the device with. At this page you can also setup the device display **Language** and **Volume** of the terminal's voice (0 is mute).

Notice:

Delete Terminal will erase all users and records from the terminal, as well as delete it from your CrossChex Cloud account.

Step 6 Add Employee

In the employee management area it´s possible to add users or employees information and assign them to the created departments at **Step 4**.

At the top bar, click **“Organization”** and **“Employee”**. You´ll be able to see your created users / employees.

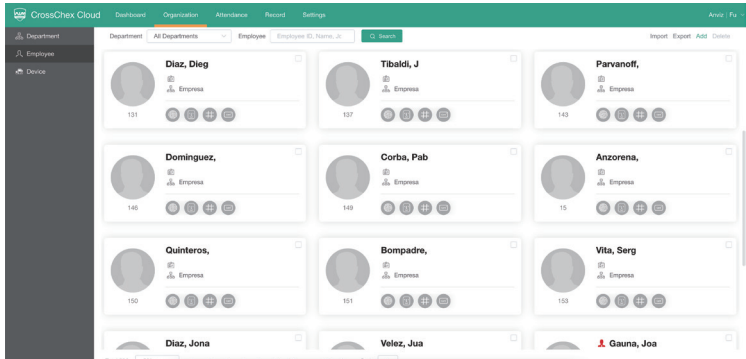

At the right side of the Employee´s page, click **“Add”** to start creating a new employee.

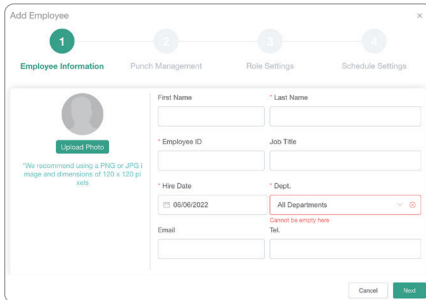
A screenshot of the 'Add Employee' form. The form has four tabs: 'Employee Information' (active), 'Punch Management', 'Role Settings', and 'Schedule Settings'. The 'Employee Information' tab contains a profile picture placeholder with an 'Upload Photo' button and a note: 'We recommend using a PNG or JPG image and dimensions of 130 x 130 pixels.' Below this are input fields for 'First Name', 'Last Name', 'Employee ID', and 'Job Title'. There are also fields for 'Hire Date' (set to 06/06/2022) and 'Dept.' (set to 'All Departments'). A red asterisk (*) is next to the 'Employee ID' and 'Dept.' fields, indicating they are mandatory. There are also fields for 'Email' and 'Tel.'. At the bottom right, there are 'Cancel' and 'Next' buttons.

The **“Add Employee”** window will popup, all items marked with a red asterisk (*) are mandatory to proceed with the enrollment.

Click **“Upload Photo”** to upload an employee picture to make the employee´s management easier at the Employee tab.

Notice:

The default employee is the administrator / account owner user, he/she will always have total control of the software. This user can be modified but cannot be deleted from your account.

The picture uploaded at this button is optional and will not be used as facial recognition, please read next steps for more details. Fill the employee information and click "**Next**" to save and proceed.

Punch Management.

Punch Mode: Select verification mode the employee will use to clock in and clock out at device time clock. (Include Fingerprint, Facial, RFID, Password and combinations)

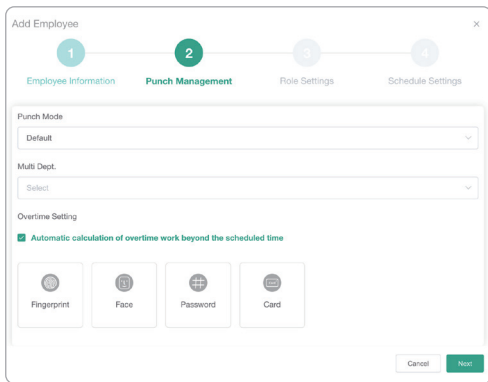

The screenshot shows a mobile application interface for adding an employee. At the top, there is a progress bar with four steps: 1. Employee Information, 2. Punch Management (current step), 3. Role Settings, and 4. Schedule Settings. Below the progress bar, the 'Punch Mode' is set to 'Default'. The 'Multi Dept.' dropdown is set to 'Select'. Under 'Overtime Setting', the checkbox 'Automatic calculation of overtime work beyond the scheduled time' is checked. At the bottom, there are four buttons for verification methods: Fingerprint, Face, Password, and Card. The 'Next' button is highlighted in green.

Notice:

The Default mode means that any technology can be accepted, for example, if this employee has password, RFID card and facial template, the first one from those three enrolled data will be valid for a clock In or a clock Out.

Multi Dept: this is where you can set specific permissions for each employee. Select the additional departments the employee will be also be able to clock In and clock Out in this field.

Automatic calculation of overtime work beyond scheduled time : if the employee has an overtime beyond the scheduled limit at his/her shift and overtime settings, it will be shown at his/her overtime reports by filling this box.

Enrollment Options.

At the bottom of this window you ´ll be able to choose the employee´s enrollment method. For example, click "Face" button to enroll employee´s facial template.

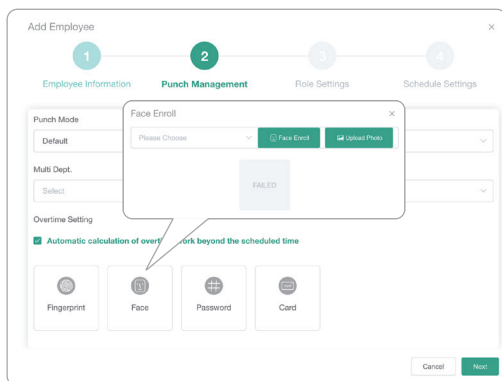

The screenshot displays the 'Add Employee' interface, which is divided into four steps: 1. Employee Information, 2. Punch Management (currently active), 3. Role Settings, and 4. Schedule Settings. In the 'Punch Management' section, there are fields for 'Punch Mode' (set to 'Default'), 'Multi Dept.' (set to 'Select'), and 'Overtime Setting' (with a checked box for 'Automatic calculation of overtime work beyond the scheduled time'). Below these fields are four enrollment options: 'Fingerprint', 'Face', 'Password', and 'Card'. A 'Face Enroll' dialog box is open over the 'Face' option, showing a 'Please Choose' dropdown, 'Face Enroll' and 'Upload Photo' buttons, and a 'FAILED' message. The 'Next' button is visible at the bottom right of the main form.

Face Enroll

Please choose and select the device for real time enrollment, then click **"Face Enroll"** to activate the terminal's enrollment mode. Please follow the steps on the device's display or voice prompt to enroll the employee's face.

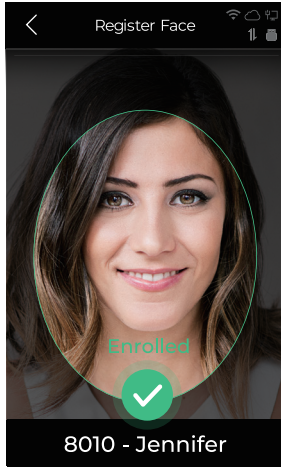

Upload Photo

If the employee is not nearby, the upload photo option is more convenient than real-time enrollment.

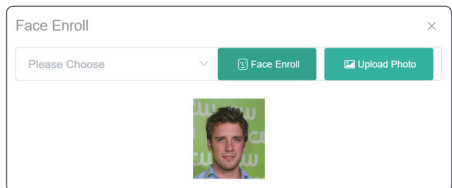
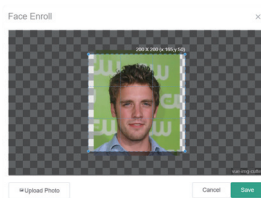
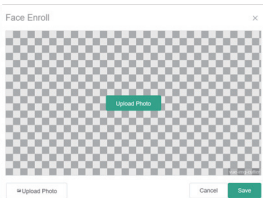

Click “**Upload Photo**” in the next window and select the chosen photo. Use the blue square to adjust the recognition area to the Employee’s Face.

Click “**Save**” and click “**X**” at the top right corner to finish employee’s enrollment operation. Click “**Next**” to proceed to Role Settings.

Role Settings

Enable a log in page for the selected employee. The default is **Inactive**, the employee will not be able to log in at his/her CrossChex Cloud account.

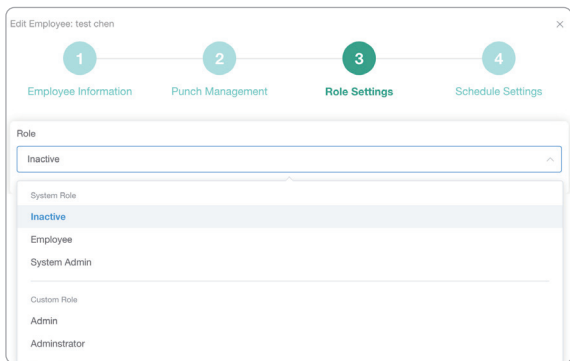

Employee: Select Employee option If this is a regular employee and you intend to authorize him/her to add manual records, request overtime, inform sick leave, vacation, etc.

System Admin: Choose System Admin if this employee will have system administration privileges similar to the account owner.

Custom Role (Supervisor): The selected employee will have customized privileges, according to what you have set at **Settings > Role page**.

Password: Fill it with a simple password and share it to the employee in advance, The employee will be able to log into his / her own account and modify it.

Click “**Next**” to proceed to Scheduled Settings.

Scheduled Settings

You can assign a working shift for this specific employee. It's possible to navigate by months with the arrows **<Prev and Next>** to see existing scheduled shifts or simply click in any day to add this employee a working shift.

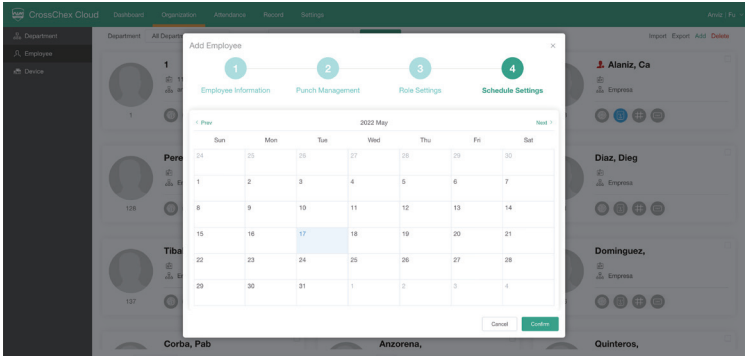

By clicking a specific day, you can input the start and end Date for the shift.

Select the shift name in the Shift drop-down box.*

Select **“Exclude Holiday”** and **“Exclude Weekend”** to consider such days as rest day, the shift scheduling will skip them accordingly.

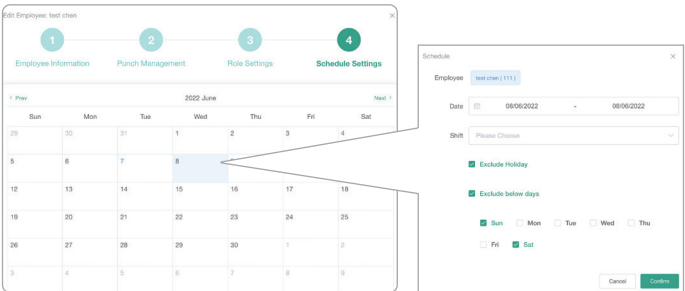

Click **“Confirm”** to save the shift schedule.

* If you have not created a shift yet please skip this part and check the CrossChex Cloud manual in further.

Step 7 Device Wall Mount

The CX7 terminal support desktop and wall mount installation.

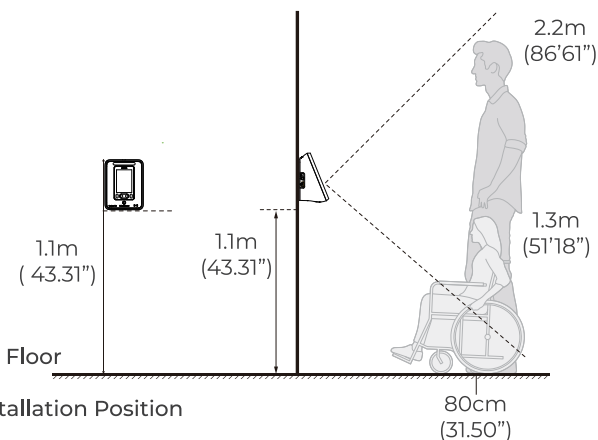

Fig.(1) Installation Position

(Recommended Distance for Face Recognition)

Installation Position

1 The recommended face recognition horizontal distance is 30-80cm (11.81-31.50").

The best adaptive angles are $\pm 20^\circ$ both horizontally and vertically

2 The recommended vertical installation is 1.1m (43.31"), where the CX7 can recognize enrolled faces from 1.3m (51.18") to 2.2m (86.61") height.

Terminal Installation

1 Place the backplate at the appropriate position and fix screws into the wall according to the mounting holes.

2 Fix backplate and connect cables. (Include LAN, Power Cable and Access Control connections when necessary).

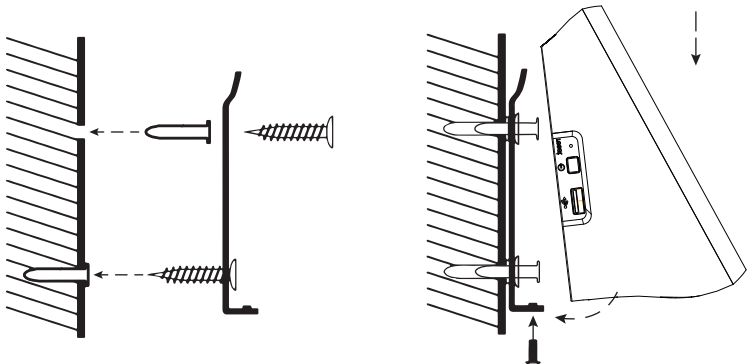

3 Fix the device on the backplate and fix the bottom screw.

Step 8 CX7 Access Control Wiring

The CX7 terminal support access control functions as described

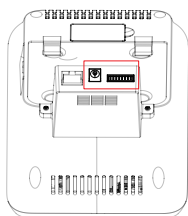

| Access Control I/O | | | | | | | | |
|--------------------|---------------|-------------|------|-------|----------------|-------------|--------------|-----|
| Function | Wiegand Input | | Exit | GND | Wiegand Output | | Relay Output | |
| | W10 | W11 | D/S | GND | W01 | W00 | NC | COM |
| Function | Bell(5V) | Door Sensor | GND | RS485 | NULL | Power Input | Relay Output | |
| | Bell | D/M | GND | 485B | 485A | | 12V | NO |



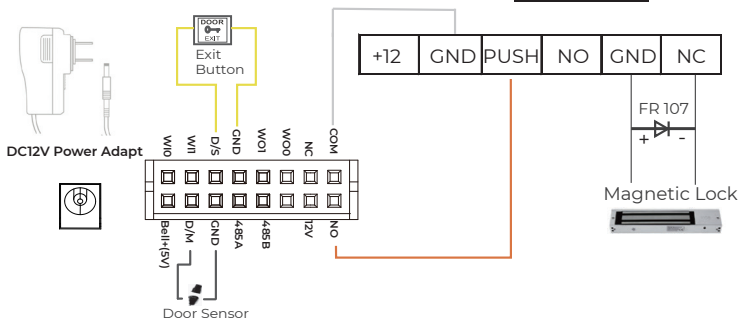

Access Control Power Su
 INPUT:AC110/230 V 50HZ
 OUTPUT:DC12V, 3Amps+

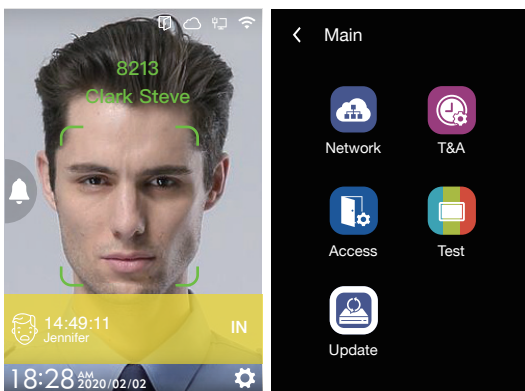

Step 9 Device Operation

To be reviewed after CX7 connection with the cloud software.
There are four status icon display on the right top of the screen:



-  The status of the WIFI connection.
-  The status of the LAN connection.
-  The status of the Cloud connection.
-  The status of the Access Control.
-  Click then enter Admin ID and Password to access the main menu.
(The default ID "0", password "12345")

Network Settings - Ethernet

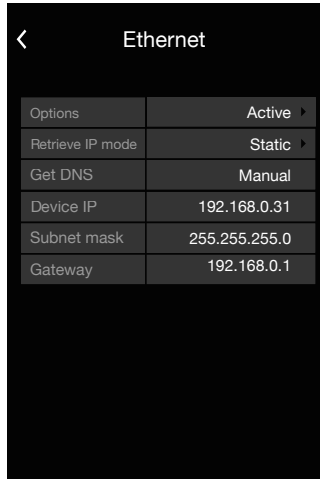
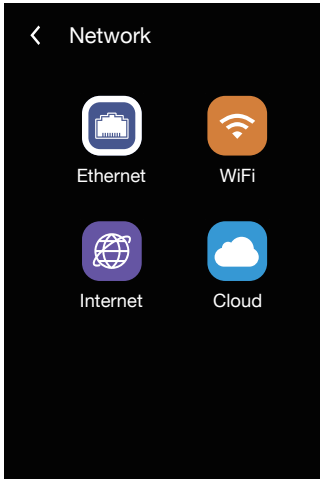

Network: Setup the terminal network connection. Include the Ethernet, WiFi, Internet and Cloud connection.

Select “**Ethernet**” option to set up the IP/Network information for the device via the network cable.

Option: Active or inactive the network communication based on cable.

Retrieve IP Mode: Select “Static” for fixed IP or “DHCP” for dynamic IP mode.

Static: Fixed IP address that doesn't change.

DHCP: A network server that automatically provide and assign IP addresses, default gateway and so on.

Get DNS: Select between “Manual” or “Auto”.

Manual: Get the DNS by setup in the “Internet” option (11.3).

Auto: Get the DNS by local network system.

Device IP: Set the device IP manually in case Static IP mode (Default: 192.168.0.218).

Subnet Mask: Set the device Subnet mask manually in case Static IP mode (Default: 255.255.255.0).

Gateway: Set the device Gateway manually in case Static IP mode (Default: 192.168.0.1).

Network Settings – WiFi

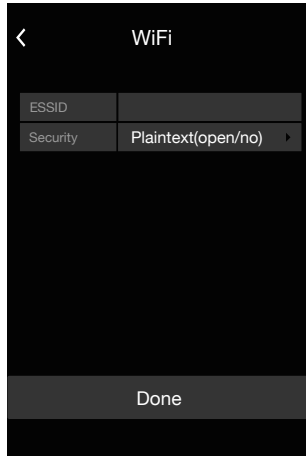
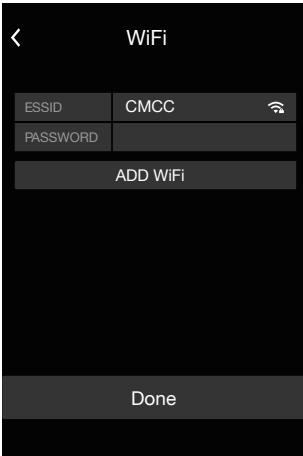
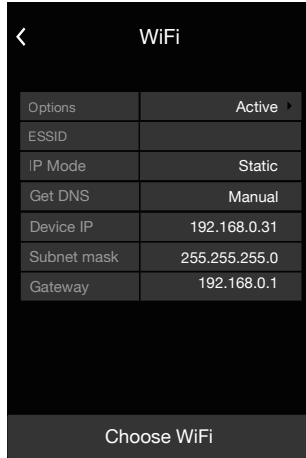
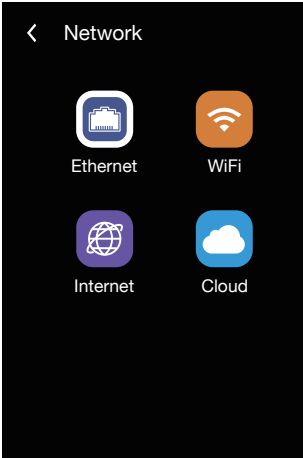

Select the “WiFi” option to set up the wireless connection of the terminal.

Option: Active or inactive the WiFi network communication.

ESSID: Displays the connected WiFi ESSID.

IP Mode: “Static” for fixed IP or “DHCP” for dynamic IP mode.

Get DNS: Select between “Manual” or “Auto”.

Manual: Get the DNS by setup in the “Internet” option (11.3).

Auto: Get the DNS by local network system.

Device IP: Set the device IP manually in case Static IP mode (Default: 192.168.0.218).

Subnet Mask: Set the device Subnet mask manually in case Static IP mode (Default: 255.255.255.0).

Gateway: Set the device Gateway manually in case Static IP mode (Default: 192.168.0.1).

Choose WiFi: Select the WiFi SSID and input Password to connect the WiFi .

Add WIFI: Manual to add WIFI SSID (Use to connect hide SSID)

Network Settings – Internet

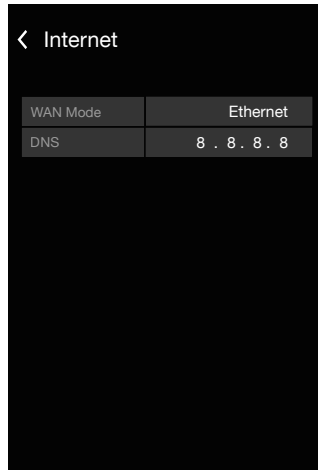
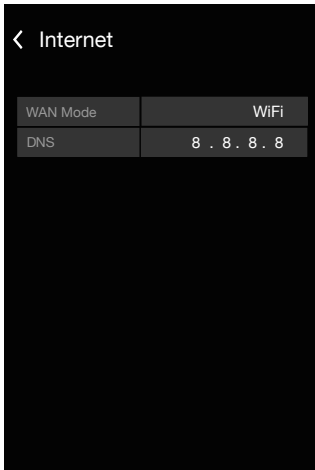

WAN mode: Select the preferential communication method for your device, choose between **WiFi** or **Ethernet**.

If you have already connected or intend to connect the device by Ethernet, select the **Ethernet** option.

If you have already connected or intend to connect the device by WiFi, select the **WiFi** option.

If you have already connected and configured the device by both ways, select the best performance way.

DNS: Please define the DNS address here if you choose the Manual option at Get DNS field in Ethernet and/or WiFi configuration option.

Network Settings – Cloud

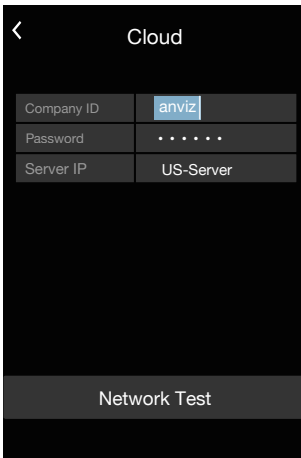

The screenshot shows a mobile application interface for configuring Cloud settings. At the top, there is a back arrow and the title "Cloud". Below this, there are three input fields arranged in a table-like structure:

| | |
|------------|-----------|
| Company ID | anviz |
| Password | •••••• |
| Server IP | US-Server |

At the bottom of the screen, there is a button labeled "Network Test".

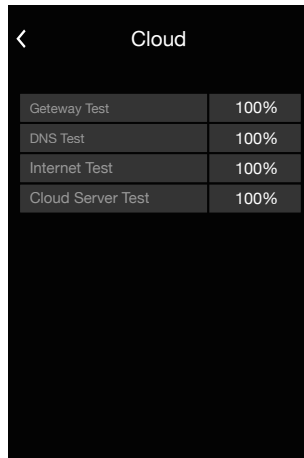

The screenshot shows the same mobile application interface after a network test. The test results are displayed in a table below the configuration fields:

| | |
|-------------------|------|
| Gateway Test | 100% |
| DNS Test | 100% |
| Internet Test | 100% |
| Cloud Server Test | 100% |

Company ID & Password: Enter the Company ID & Password registered in your CrossChex Cloud account.

Server IP: US Server.

Network Test: Test the connectivity between the device and the CrossChex Cloud.

T&A (Time and Attendance Settings)

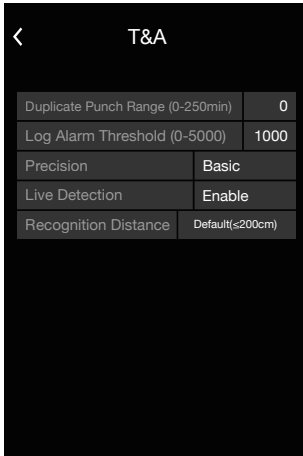

| T&A | |
|----------------------------------|-----------------|
| Duplicate Punch Range (0-250min) | 0 |
| Log Alarm Threshold (0-5000) | 1000 |
| Precision | Basic |
| Live Detection | Enable |
| Recognition Distance | Default(≤200cm) |

Duplicate Punch Range(0-250min): Set the time interval for repeated punching of the same employee to prevent system from generating duplicate punching records (Default: 0).

Log Alarm Threshold (0-5000): The device will emit an alarm when the log records reach the number inserted on this field to inform the log memory is almost full. (Default: 0).

Identify Precision: Facial template comparison accuracy (Default: Basic).

Live Detection: Enable or Disable the capacity to recognize live faces (Default: Enable)

Recognition Distance: Chosen distance to validate a check in or check out record.

(Default: equal or less than 200cm / 78.74"

Access (Access Control Settings)

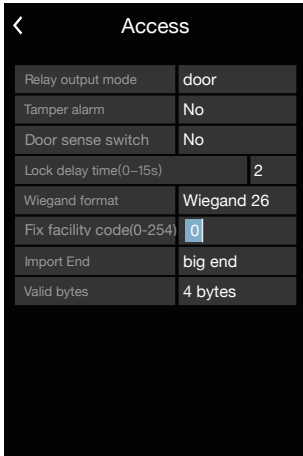

| Access | |
|--------------------------|------------|
| Relay output mode | door |
| Tamper alarm | No |
| Door sense switch | No |
| Lock delay time(0-15s) | 2 |
| Wiegand format | Wiegand 26 |
| Fix facility code(0-254) | 0 |
| Import End | big end |
| Valid bytes | 4 bytes |

Tamper Alarm: Active the tamper alarm function in the terminal (Default: No).

Door Sensor Switch: Active the door sensor alarm. Setup time range from 0~20 sec (Default: Zero/No).

Lock Delay Time(0-15s): Setup the relay delay time 0~15 secs (Default: 5 secs)

Wiegand Format: Define the terminal Wiegand output format, the CX7 supports up to 11 Wiegand types. (Device Wiegand\Wiegand 26 \Wiegand26BE\Wiegand26LE\Wiegand34BE\Wiegand34LE\Card24Big\Card24Little\Card32Big\Card32 Little\Fix Wiegnd Code)

Fix Facility Code: Self-defined head of the Wiegand code output. To be integrated with existing access control system.

Fix Wiegand code (0-254): Self-defined head of the Wiegand code range from 0~254 code number.

Test & Update

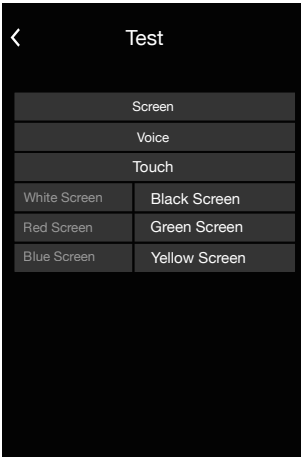

The Test mode: the user can test device ´s keyboard, LCD display and speaker (alarms and voices).

The Update: to update the terminal's firmware via the USB flash drive.

Warranty and Disclaimer

Anviz warrants that the hardware will be free from material defects in materials and workmanship and will substantially conform to the applicable Documentation in effect as of the date of manufacture for a period of three (3) years from the date of shipment by Anviz (“Warranty Period”). For more warranty information about this product, please visit www.anviz.com/warranty-policy

Shipping Fees

End Customer is responsible for the shipping fee for sending the product to Anviz, and the return shipping fee for sending the product back to customers is borne by Anviz (paying for one-way shipping). However, if the device is considered as No Fault Found, which means the device works normally, the returning shipment, too, is borne by End Customer (paying for round-trip shipping).

Return Merchandise Authorization (“RMA”) Process

Please fill out the Anviz RMA request form online

<https://www.anviz.com/form/rma.html>

and ask technical support engineer for an RMA number.

You will receive the RMA confirmation with RMA number in 72 hours, after receiving an RMA number, please send the product in question to Anviz by following the Anviz shipment guide.

When the inspection of the product is completed, you receive an RMA report from technical support engineer. Anviz decides to repair or replace parts after user confirmation.

When the repair is completed, Anviz notifies user of that and sends the product back to you.

An RMA number is valid for two months from the date of its issuance.

An RMA number that is more than two months old is null and void, and in such a case, you need to get a new RMA number from Anviz technical support engineer.

Products without a registered RMA number will not be repaired.

Products shipped without an RMA number may be returned, and Anviz will not be held responsible for any loss or other damage caused by this.

Questions?



Call

855-ANVIZ4U | 855-268-4948
MON-FRI 5AM-5PM Pacific



Text

408-837-7536
MON-FRI 5AM-5PM Pacific



Email

support@anziv.com
24 Hours Answer



Community

Join community.anziv.com
if you have any question or
suggestion to share



Anviz brand and product are trademarked and protected under law of the United States. Unauthorized use is prohibited.

For more information visit www.anziv.com, or email marketing@anziv.com for further help.

©2022 Anviz Global Inc. All Rights Reserved.