

CX2

Fingerprint and Card Time Clock

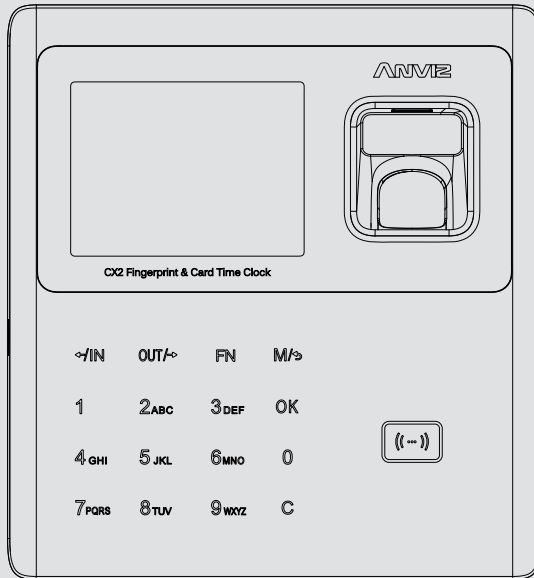

User Guide

Before Starting

Hardware Safety Instructions

Observe the following instructions to use the product safely and prevent any risk of injury or property damage.

Do not use oily water or sharp objects to stain or damage the display screen.

Fragile parts are used in the equipment, please avoid operations such as falling, crashing, bending or heavily pressing.

The optimal working environment of CX2 is indoor. The device function fully under temperature: $-10^{\circ}\text{C}\sim 50^{\circ}\text{C}$ ($14^{\circ}\text{F}\sim 122^{\circ}\text{F}$), The best performance is between: $15^{\circ}\text{C}\sim 32^{\circ}\text{C}$ ($59^{\circ}\text{F}\sim 89.6^{\circ}\text{F}$). The device will be less effective if exceeds these ranges.

Please gently wipe the screen and panel with soft materials. Avoid scrubbing with water or detergent.

The recommended power of CX2 terminal is DC 12V ~ 1A. The device will function less effective in case the power supply cable extends too long.

ANVIZ Terms & Policies

Before using all ANVIZ products, please read all applicable terms rules, policies and usage provisions found at www.anviz.com/privacypolicy and www.anviz.com/anviz-biometric-data-retention-policy.

By using your ANVIZ products, you agree to be bound by the ANVIZ Terms & Policies.

Packing List

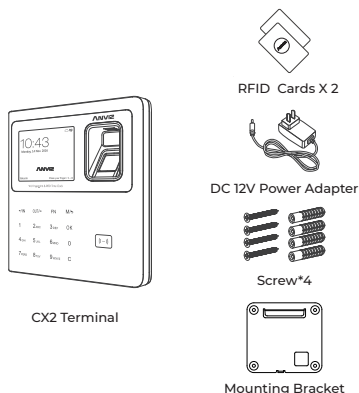

Product Introduction

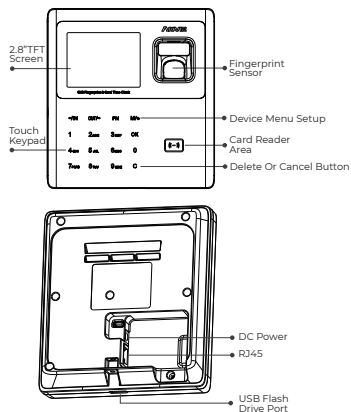

1. Create CrossChex Cloud Account

Before setting up your new CX2, it's necessary to create a CrossChex Cloud Account.

CrossChex Cloud is a cloud-based time and attendance management system, you can use it anywhere over internet with any internet browser. Open your web browser and visit <https://us.crosschexcloud.com> Then click "Sign up for a new account"

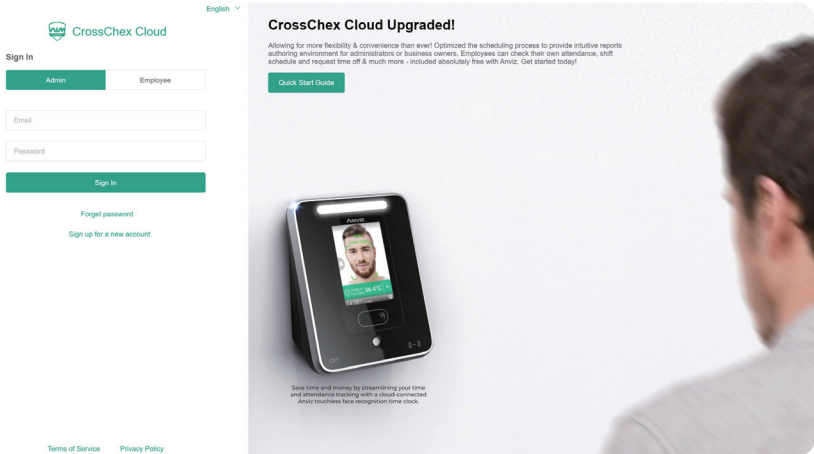

Please fill the E-mail and Password fields, We suggest read Terms of Service and Privacy Policy.

Then fill the **"Agree to Anviz Global Terms of Service and Privacy Policy."** box to continue.

Click Register to proceed.

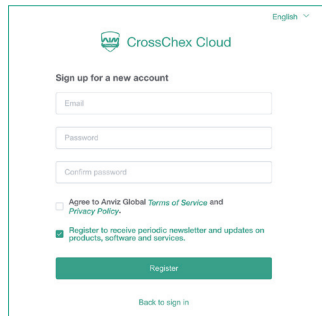

Notice:

The **"Register to receive periodic newsletter and updates on products, software and services"** is optional, feel free to choose it or not.

2. Pre-Setting your CrossChex Cloud

Use the same e-mail and address you Created to Log In.

CrossChex Cloud will forward you to the pre-settings pages to fill the basic information. Please make sure to fill them correctly, especially the Time Zone field, it will be used as reference to synchronize your Time Clock devices with the correct date and time.

Hey! Help us create the best experience for you! 1/3

Organization Information Your Details Date & Time

Company Logo

Upload Logo

*We recommend using a PNG or JPG image with dimensions of 128 x 128 pixels

Organization Name

Industry

Organization Size

1 - 10	11 - 20	21 - 50	51 - 100	100+
--------	---------	---------	----------	------

Continue

Hey! Help us create the best experience for you! 2/3

Organization Information Your Details Date & Time

← Back

First Name Last Name Job Title

Country

State

City

Address

Phone Number

+ 001

Continue

Hey! Help us create the best experience for you! 3/3



Organization Information



Your Details



Date & Time

← Back

Time Zone

(UTC+8:00) Australian Western Standard Time, Beijing Time

Date Format

mm/dd/yyyy

Time Format

12h

[Done](#)

CrossChex Cloud
Dashboard
Organization
Attendance
Record
System
Anviz Global Inc
Admin

System Information

Admin Role

Admin User

Holiday

System Information



Company Logo

Upload

* We recommend using a PNG or JPG image and dimensions of 120 x 120 pixels.

Organization QR Code

You can print the QR Code and your employees scan to join your organization. Please complete the organization information on the right before creating the QR Code.

Company ID

Connection Password

Company Name

Company Address

Country

State

Phone Number

Please save your account's **Company ID** and **Cloud Password** at the Settings tab, we'll use them to connect the Time Clock with the CrossChex Cloud system.

3. Activate your Time Clock

The Time Clock can be connected with the internet by Ethernet cable (LAN) or WiFi.

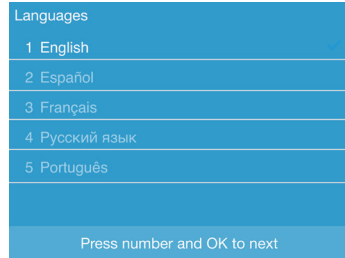

1. Plug your Time Clock into a power outlet to power on the terminal.
2. Choose your preferred language by press the number key, then press "OK" to save the selected option and move to the next step.

3.1 Time Setting

1. Choose your preferred Time Clock display time format by input the number key, then press "OK" to save the selected option and move to the next step.
2. Crosschex Cloud software will be used to synchronize your Time Clock devices with the correct date and time. Press M key return to previous settings.

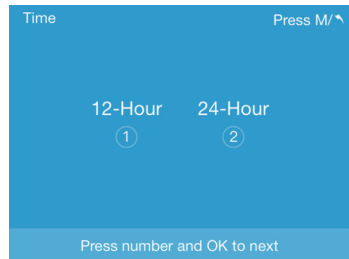

3.2 Network Setup by Cable (LAN)

1. Connect a LAN cable between your clock and a router with internet access.
2. Press number 1 to select "Ethernet" as the preferred the network mode.
3. Select "DHCP" in the IP mode to automatic get the network information or fill the correct network information in the terminal (IP address, Subnet mask and Gateway) to connect with internet. Select the "Next(OK)" and press"OK" to proceed.

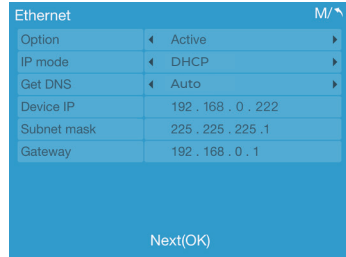
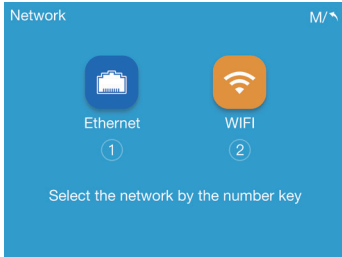

3.3 Wireless Network Setup (WiFi)

1. Press number 2 to select “WiFi” and choose the network (SSID)
2. Insert the WiFi password and press OK to finish the WiFi setup. After WiFi connected the terminal will next proceed Cloud Setup. Press FN key to input the password with characters.

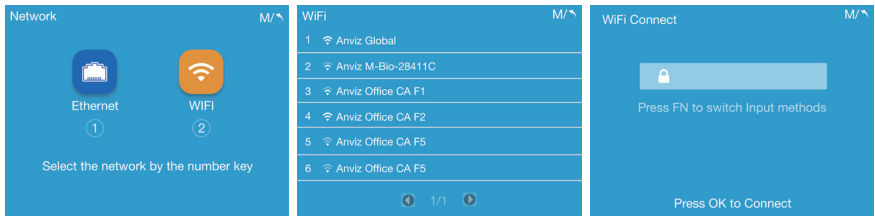

3. After WiFi connected the terminal will to next Cloud Setting process.
4. The Time Clock that failed to connect will manually reset WiFi after 3 seconds.

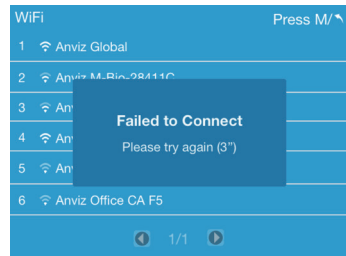
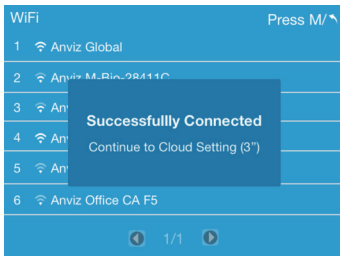

3.4 Cloud Setting

1. Fill the Company ID and Password in the Time Clock. Select the “Next (OK)” and press “OK” to detect the cloud connection.

(The Company ID and Password can be found in the Settings tab of your CrossChex Cloud Account. If you do not have an account yet, please check <Creat CrossChex Cloud Account> of this manual.)

2. After Cloud connected please Press OK to next starting your application.

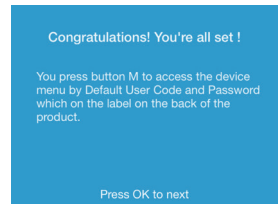
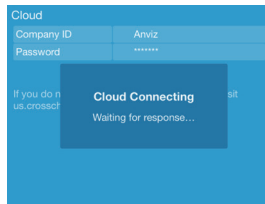
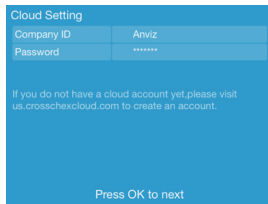

3. Please check your Time Cloud's Cloud Icon at the top of the Screen and device will be shown at Device Tab of your CrossChex Cloud.

4. And press M button to device menu by input the default Admin ID and Password.

Default Admin ID: 0 Password: 12345

Notice: Please change the default password from the Cloud software for security concerns.

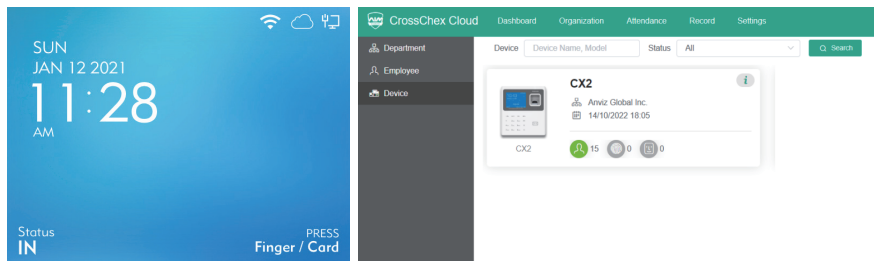

4.FAQ

The Time Clock cloud not sign in the CrossChex Cloud

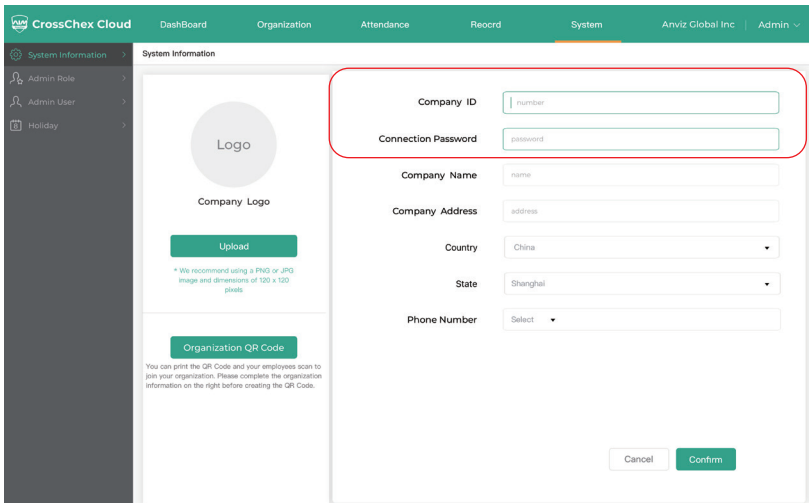
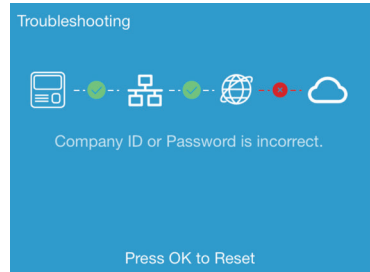
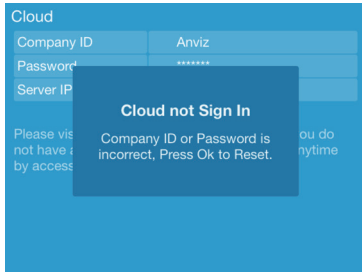

1. Press System OK to reset the Company ID and Password in the Time Clock.
2. Please make sure to fill the correct Company ID and Password. The Company ID and Password can be found in the Settings tab of your CrossChex Cloud Account.
3. If you do not have an account yet, please check <Creat CrossChex Cloud Account> of this manual.

The Time Clock connect CrossChex Cloud Timeout

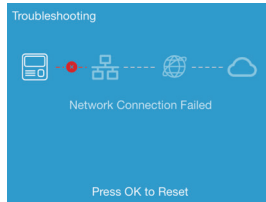
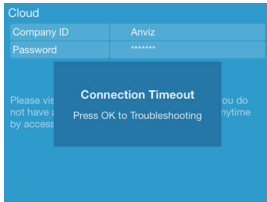

1. Press OK to Network Troubleshooting.

2. **Network Connection Failed.** Press OK to reset the network.

Notice: Please check for Physical Connectivity Issues. For wired connections, check the Ethernet cables that connect to your router. And the network setting is correct include the IP, Gateway and DNS

3. **No Internet Access.** Press OK to reset the network.

Notice: Please check the time clock network setting. Include the IP, Gateway and DNS. If you're on a Wi-Fi network, you should know that the connection performance depends on the distance between your wireless access point and your device.

How to change the Time Clock default Password

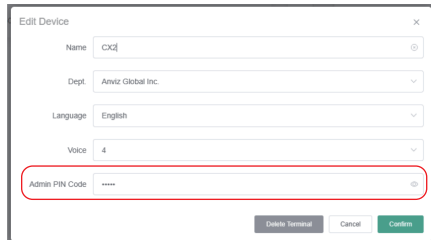
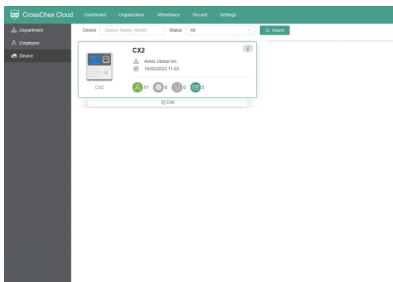

1. Select the Time Clock in the Device Tab of your CrossChex Cloud and click "Edit" to change the device Admin Pin Code.

2. The Admin Pin Code is a numeric-only password at maximum 6 digits.

5. Time Clock Installation

Installation Diagram

1. Drill outlet hole on the wall for device wiring and 4 screw holes on the wall according to the mounting bracket.
2. Use the screws to fix the mounting bracket on the wall. Use the screwdriver to tighten the screw follow the direction indicated, to complete the installation.

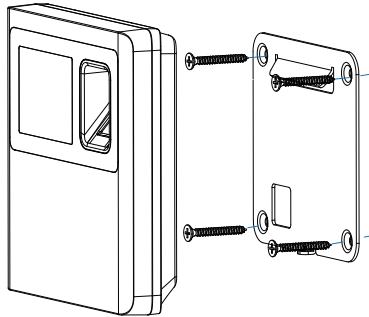

6. Support

Congratulations! You've done the all configurations! If you need more support we suggest visiting Anviz Community community.anviz.com, a platform for sharing your Anviz products' experiences and interacting directly with Anviz employees.

**CrossChex Cloud
Help Center**



**CX2 Time Clock
Configuration Guide**



Warranty and Disclaimer

Anviz warrants that the hardware will be free from material defects in materials and workmanship and will substantially conform to the applicable Documentation in effect as of the date of manufacture for a period of three (3) years from the date of shipment by Anviz (“Warranty Period”). For more warranty information about this product, please visit www.anviz.com/warranty-policy

Shipping Fees

End Customer is responsible for the shipping fee for sending the product to Anviz, and the return shipping fee for sending the product back to customers is borne by Anviz (paying for one-way shipping). However, if the device is considered as No Fault Found, which means the device works normally, the returning shipment, too, is borne by End Customer (paying for round-trip shipping)

Return Merchandise Authorization (“RMA”) Process

Please fill out the Anviz RMA request form online <https://www.anviz.com/form/rma.html> and ask technical support engineer for an RMA number. You will receive the RMA confirmation with RMA number in 72 hours, after receiving an RMA number, please send the product in question to Anviz by following the Anviz shipment guide. When the inspection of the product is completed, you receive an RMA report from technical support engineer. Anviz decides to repair or replace parts after user confirmation. When the repair is completed, Anviz notifies user of that and sends the product back to you. An RMA number is valid for two months from the date of its issuance. An RMA number that is more than two months old is null and void, and in such a case, you need to get a new RMA number from Anviz technical support engineer. Products without a registered RMA number will not be repaired. Products shipped without an RMA number may be returned, and Anviz will not be held responsible for any loss or other damage caused by this.

Questions?



Call

855-ANVIZ4U | 855-268-4948
MON-FRI 5AM-5PM Pacific



Text

408-837-7536
MON-FRI 5AM-5PM Pacific



Email

support@anviz.com
24 Hours Answer



Community

Join community.anviz.com
if you have any question or
suggestion to share



Anviz brand and product are trademarked and protected under law of the United States. Unauthorized use is prohibited.

For more information visit www.anviz.com, or email Support@anviz.com for further help.

©2023 Anviz Global Inc. All Rights Reserved.